



Cremona giochi & arredi



JOMSI
SEATING FOR BIG EVENTS





Since 1961

JOMSI TWIN
SNE
TWO
RK
SEATING FOR BIG EVENTS

ARREDO
FURNITURE

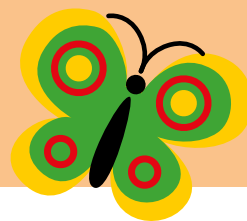
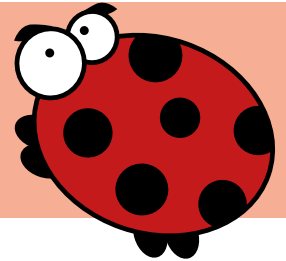

MATERNA
KINDERGARTEN

NIDO
NURSERY

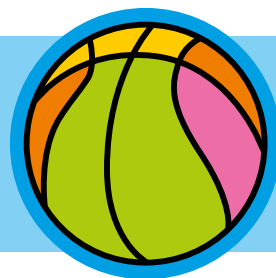
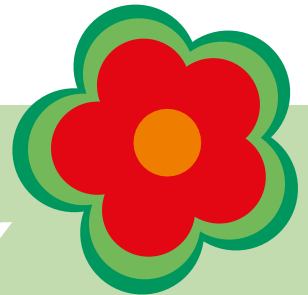

SPORT











CERTIFICATO/CERTIFICATE
ICILA-SGQ-001099

SI CERTIFICA CHE/WE HEREBY CERTIFY THAT
IL SISTEMA DI GESTIONE PER LA QUALITÀ DI
THE QUALITY MANAGEMENT SYSTEM OPERATED BY

OMSI S.r.l.

SEDE LEGALE/REGISTERED OFFICE: Via Parini, 3 - 40069 Zola Predosa (BO) - ITALIA

UNITA' OPERATIVE CERTIFICATE/CERTIFIED OPERATIVE UNITS
Via Parini, 3 - Z.I. - 40069 Zola Predosa (BO) - ITALIA

È CONFORME ALLA NORMA/IS IN COMPLIANCE WITH THE STANDARD
UNI EN ISO 9001:2008

PER LE SEGUENTI ATTIVITÀ/FOR THE FOLLOWING ACTIVITIES
Progettazione, produzione, commercializzazione e posa in opera di sedute,
strutture ed accessori per il settore sportivo, collettività e scuola,
realizzati in materiali termoplastici e ferrosi.

Design and manufacturing and installation of seatings and structures for sport,
community and school fields made of thermoplastic and metallic materials.
Trading of components and accessories.

Conception de projet, production et installation de chaises et structures pour le
secteur sportif, pour la collectivité et les écoles en matériaux thermoplastiques
et en fer. Commercialisation de composantes et accessoires

EA: 14 - 17 - 29

Ing. P. Baldazzi
R. U. Sistemi / E. U. Sistemi

PRIMA EMISSIONE
FIRST ISSUE
30/05/2008

DATA DI VALIDITÀ
EFFECTIVE DATE
11/05/2017

DATA DI SCADENZA (1)
EXPIRING DATE
14/09/2018



THE INTERNATIONAL CERTIFICATION NETWORK

CERTIFICATE

IQNet and CISQ/CSI-ICILA hereby certify that
the organization

OMSI S.r.l.
registered address: Via Parini, 3 - 40069 Zola Predosa (BO) - Italy

has implemented and maintains a
Quality Management System
which fulfills the requirements of the following standard
UNI EN ISO 9001:2008
field of activities

**Design and manufacturing and installation of seatings and structures
for sport, community and school fields made of thermoplastic and metallic
materials. Trading of components and accessories.**

sites included in the certification
Via Parini, 3 - Z.I. - 40069 Zola Predosa (BO) - Italy

Issued on: 2017/05/11 Validity date: 2018/09/14
Registration Number: **IT-54179**



Michael Dreuchel
President of IQNet





Ing. Claudio Proietti
President of CSI



Via Parini, 3
40069 Zola Predosa (BO) Italy
Tel. +39 051 6164311

Fax +39 051 6164317
info@omsi.it - soft@omsi.it
www.omsi.it

DICHIARAZIONE FTALATI

Phthalates	Ppm max
Di-iso-nonylphthalate (DINP - CAS-Nr. 28553-12-0, 68515-48-0)	0.01
Di-n-octylphthalate (DNOP - CAS-Nr. 117-84-0)	0.01
Di(2-ethylhexyl)-phthalate (DEHP - CAS-Nr. 117-81-7)	0.01
Diisodecylphthalate (DIDP - CAS-Nr. 26761-02-0, 68515-49-1)	0.01
Butylbenzylphthalate (BBP - CAS-Nr. 85-68-7)	0.01
Dibutylphthalate (DBP - CAS-Nr. 84-74-2)	0.01
Di-iso-butylphthalate (DIBP - CAS-Nr. 84-69-5)	0.01
Di-CF-11-branched alkylphthalates (DINLP - CAS-Nr. 71888-89-6)	0.01
Di-n-herylphthalate (DHP - CAS-Nr. 68515-41-4)	0.01
Di-(2-methoxyethyl)-phthalate (DMEP - CAS-Nr. 11782-8)	0.01
Di-pentylphthalate (DPP - CAS-Nr. 131-18-0)	0.01
Di-hexylphthalate, branched and linear (DHP - CAS-Nr. 68515-50-4)	0.01
Di-iso-hexylphthalate (DHP - CAS-Nr. -)	0.01

GREEN COVER / 101

TEST	result long / strong - heavy / across	method
conform to structure	≥ 100 N/20cm	ISO 17708
tear strength	300-1000 N	UNI 4878-7
elongation @ 20 N	≥ 10 N	ISO 17898
elongation @ 50 N	≥ 8 N/mm	ISO 47698
elongation @ 100 N	≥ 10.000 colt - cycles	ISO 17894
elongation @ 200 N	≥ 2.000 colt - cycles	ISO 17704
elongation @ 500 N	≥ 100000 colt - cycles	ISO 17704
elongation @ 1000 N	≥ 10000 colt - cycles	UNI EN ISO 105-803
elongation @ 2000 N	≥ 10 scale dia blu - blue scale	PERMAGRID
elongation @ 5000 N	5/5	UNI EN 1734
elongation @ 10000 N	1.0 mm / 50 mm	ASTM D588 (B-W)

pulver - maintenance

Washing instructions:

waterproofing: no yes

resistance to hydrogen peroxide: no yes

characteristics - characteristics

composition: 30% PU - 70% PL

weight: 1.05 g/m² ± 10%

thickness: 0.50 mm ± 10%

width: ≥ 140 cm

iNDice

iNDex



PROFILO AZIENDALE
COMPANY PROFILE p. 8

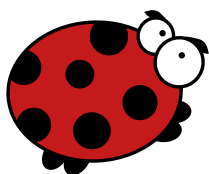

LINEA ARREDO
FURNITURE LINE p. 9

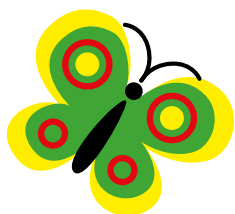

LINEA MATERNA
KINDERGARTEN LINE p. 43



LINEA NIDO
NURSERY LINE p. 91



LINEA SPORT
SPORT LINE p. 107





OMSI viene fondata nel 1961 a Zola Predosa, una delle più importanti zone industriali di Bologna, dove si specializza nello stampaggio di sedute in plastica (polipropilene e poliammide) per collettività, scuola e impianti sportivi. E' proprio in quest'ultimo settore che negli anni **OMSI** è diventata uno dei punti di riferimento del mercato Italiano ed Europeo, grazie ad una vasta disponibilità di stampi per diverse tipologie di sedute, a un attento servizio di progettazione ed a un'assistenza post vendita competente e veloce. La capacità di produrre direttamente in Italia con stabilimento e magazzino di proprietà, rendono **OMSI** una delle aziende più reattive e competitive nel panorama mondiale. Le collaborazioni con architetti, ingegneri e grandi nomi del design italiano contribuiscono a creare un prodotto che risponde ai requisiti tecnici e normativi senza tralasciare il comfort e l'aspetto estetico. Una tecnologia all'avanguardia che spazia dalla meccanica impiegata nella costruzione degli stampi alla scelta dei materiali plastici più idonei alla produzione, con la possibilità di ingegnerizzare i prodotti medesimi, sono alla base della filosofia aziendale odierna e futura. Un'intelligente diversificazione, consolidata negli anni, ha portato **OMSI** ad essere una realtà in grado di offrire prodotti, con differenti peculiarità, indirizzati ai settori più importanti dell'arredamento e che costituiscono un fattore trainante sia per una economia moderna, che per una economia minore in fase di sviluppo.

Dal 2002, **OMSI** è entrata a far parte del gruppo **TWINS**, uno dei gruppi più importanti nella produzione di componenti in plastica per sedute. Il Gruppo è presente in tutti i 5 continenti, con aziende controllate o partecipate, le quali offrono una capillare presenza sul territorio, sinonimo di serietà e competenza, portando il Made in Italy in tutto il Mondo. Nel 2013 **Omsi** ha creato la Linea Soft.

OMSI was founded in 1961 in the industrial area of Bologna. The Company has been specializing in the injection of plastic chairs made of polypropylene and polyamide for communities, school and sports facilities. Over the years, **OMSI** has become one of the reference points of the Italian and European market for this product segment, thanks to a context, Bologna, rich of projectuality and experimentation.

The great events of life, school, sport, living spaces where the people gathers together, such as offices, hospitals, big concerts, see the constant presence of **OMSI** to provide a definition of space, and seats to live events and waiting times in a harmonious and full of enthusiasm way capturing the best aspects of life. Our partnerships with architects, engineers, educators, help to create situations for a better living. The latest technology, ranging from mechanics employed in the construction of the moulds, to the choice of the best plastic materials suitable for the production, with the ability to engineer the products themselves, are the basis of our corporate philosophy today and tomorrow.

Intelligent diversification, consolidated over the years, led **OMSI** to become a reality able to offer products with different characteristics, addressed to the most important furniture sector and are a driving force for both a modern economy and for an minor economy under development. Since 2002, **OMSI** has become part of the group **TWINS**, one of the major groups in the world for the production of components for plastic chairs. Present in all five continents, with subsidiaries or associated companies, which by means of smart synergies offer a widespread presence throughout the territory which is synonymous of seriousness and competence, bringing the Made in Italy around the globe.

Besides that our customers are protected by a competent and fast after-sales service. In 2013 **OMSI** has introduced the Soft Line. The ability to produce its products directly in Italy with its factories and warehouses, made of **OMSI** one of the most reactive and competitive companies in the world scenario.



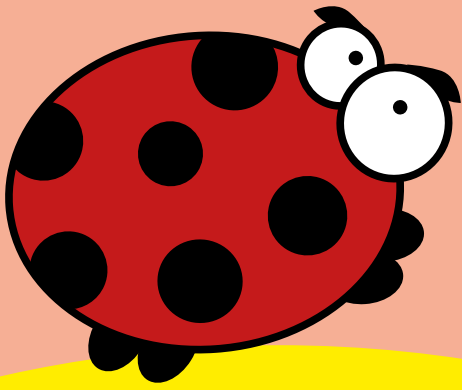

Linea arredo FURNITURE LINE



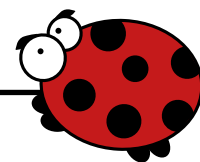

CUBEAU



Art. OM 4.011

CUBEAU

Dim. 41x 43,5 h x 43,5 cm

Per una organizzazione più definita ed efficiente degli spazi, in ambito domestico e scolastico, soprattutto nelle scuole materne design moderno, colorato e modulare può contenere tutta la gamma di vaschette portaoggetti OMSI.

Vasta gamma di colori.

For a more defined and efficient organization of spaces in the domestic and school environment, especially in kindergartens colorful, versatile, with its modern design it is suitable to contain the whole range of OMSI storage trays. Wide range of colors.

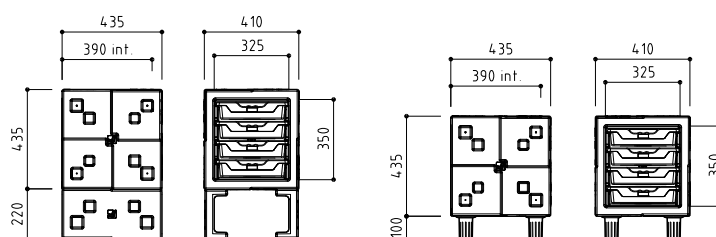

Art. OM 4.014

CUBEAU ANGOLARE / CORNER CUBEAU

Dim. 43,5 x 43,5 h x 43,5 cm

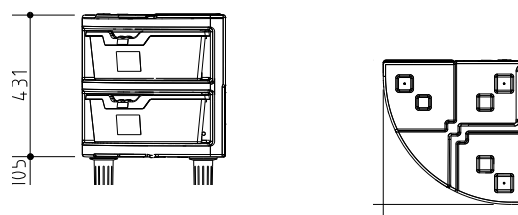



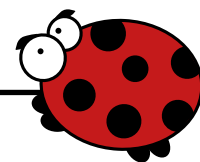

CUBEAU può essere un'originale alternativa al classico armadio in legno, si adatta facilmente a qualsiasi realtà e grazie alla sua composizione in moduli e alla sua versatilità si possono creare molteplici soluzioni di arredo:

- Colonna
- Mensola
- Divisorio
- Isola
- Seduta
- Pouf con cuscino
- Contenitore per giochi

È stato progettato con particolare attenzione alla sicurezza, infatti tutti i moduli sono fissati a parete e tra loro a mezzo di viti e le guide hanno un sistema di blocco; è atossico, robusto e riciclabile al 100%.

È caratterizzato da uno stile essenziale, pulito e compatto, le linee sono semplici e moderne, i bordi sono arrotondati ed è privo di spigoli, ampia scelta di colori e di combinazioni tra Cubeau e Vaschette.

Ideato per incoraggiare l'indipendenza dei bambini nell'organizzazione dei giocattoli o dei materiali scolastici.

CUBEAU can be an original alternative to the classic wooden cabinet, as it easily adapts to any reality and thanks to its composition in modules and its versatility it is possible to create multiple furnishing solutions:

- Column
- Shelf
- Partition
- Island
- Seat
- Pouf with pillow
- Toys Box

It has been designed with special attention to safety, in fact all the modules are fixed to the wall and between them by means of screws and the guides have a locking system;

It is non-toxic, robust and 100% recyclable.

It is characterized by a basic, clean and compact style, the lines are simple and modern, the edges are rounded to prevent any injury, available in a wide choice of colors and combinations between Cubeau and trays of several different sizes and shapes

Designed to encourage children's independence in the organization of toys or school supplies.



Art. OM 4.0505

Cuscino quadrato per Cubeau Pouf

Square cushion for Cubeau Pouf

Dim. 40x40x5h cm

Colori assortiti

Assorted colors



Tested according to EN 16121:2013





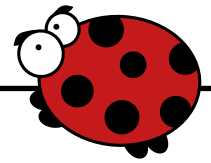

COMPOSIZIONI STANDARD STANDARD COMPOSITIONS

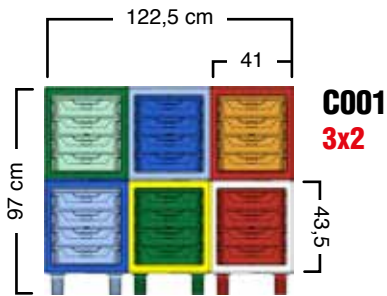

C001
3x2

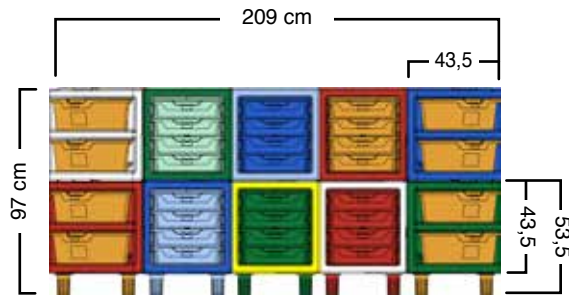

C002
3x2 + Cubeau angolare
3x2 + Corner Cubeau

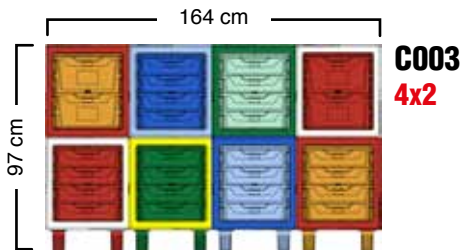

C003
4x2

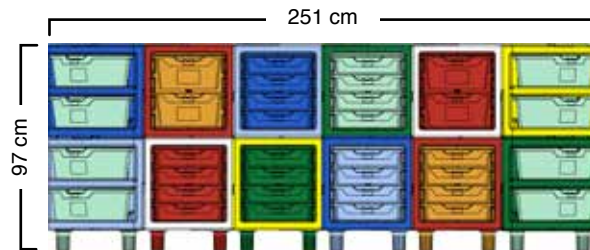

C004
4x2 + Cubeau angolare
4x2 + Corner Cubeau

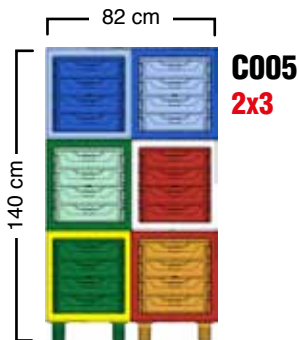

C005
2x3

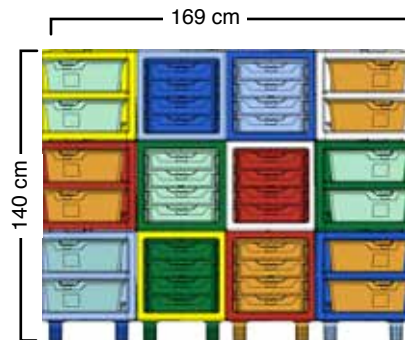

C006
2x3 + Cubeau angolare
2x3 + Corner Cubeau

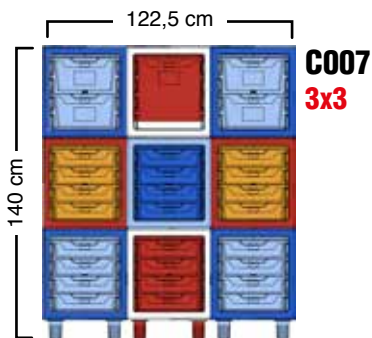

C007
3x3

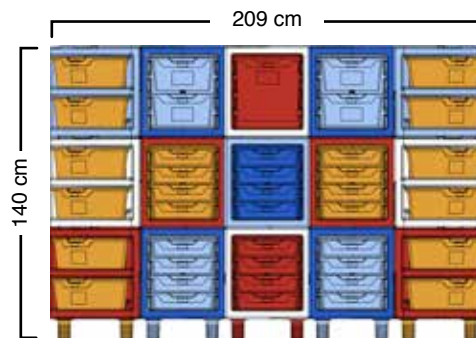

C008
3x3 + Cubeau angolare
3x3 + Corner Cubeau

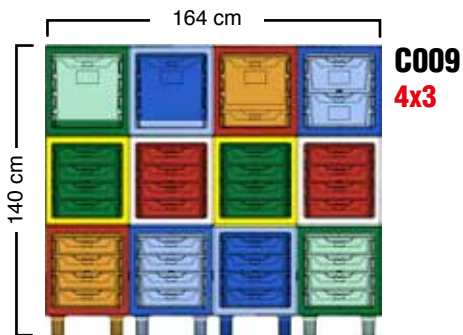

C009
4x3

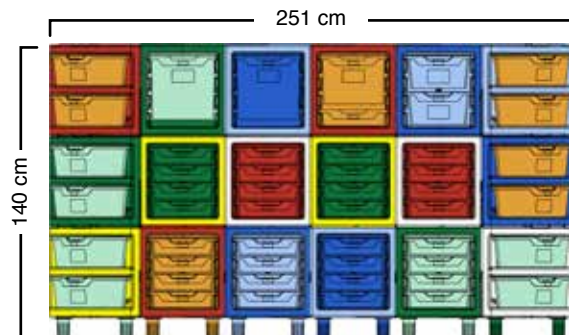

C010
4x3 + Cubeau angolare
4x3 + Corner Cubeau



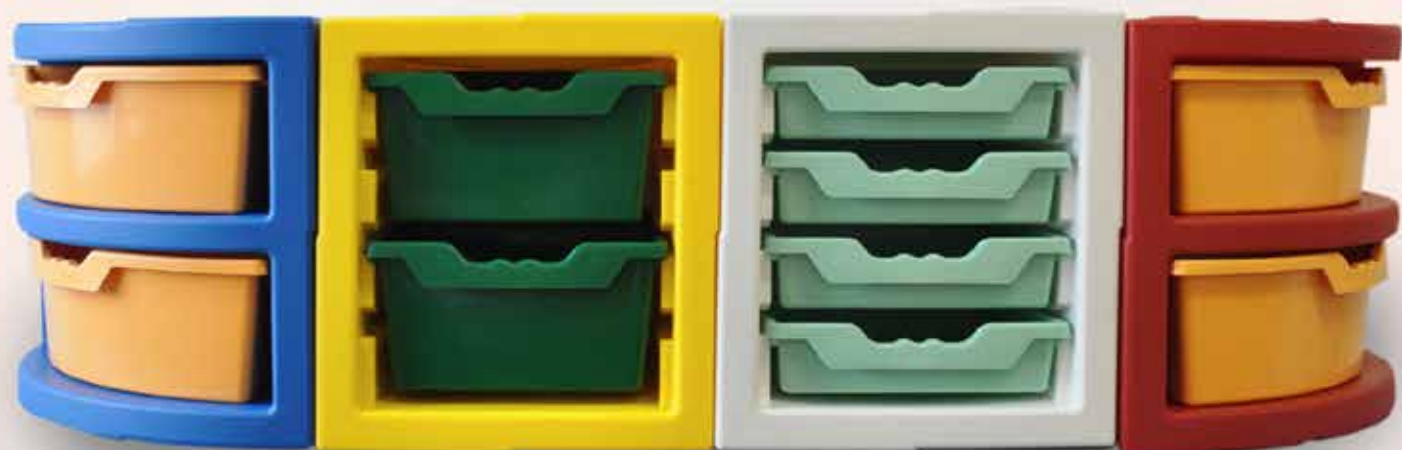

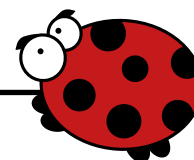

CUBEAU

COMBINAZIONI COLORE CUBEAU/VASCHETTA

COLOR COMBINATIONS CUBEAU/TRAY

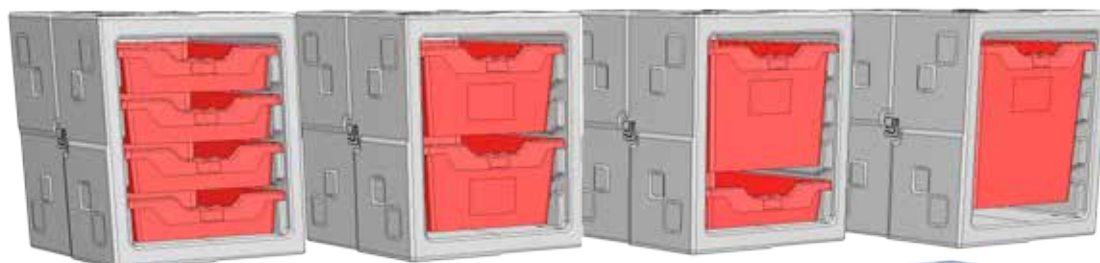

Cubeau Bianco F0001
Vaschetta Rosso RAL 3002
*Cubeau White F0001
Tray Red RAL 3002*

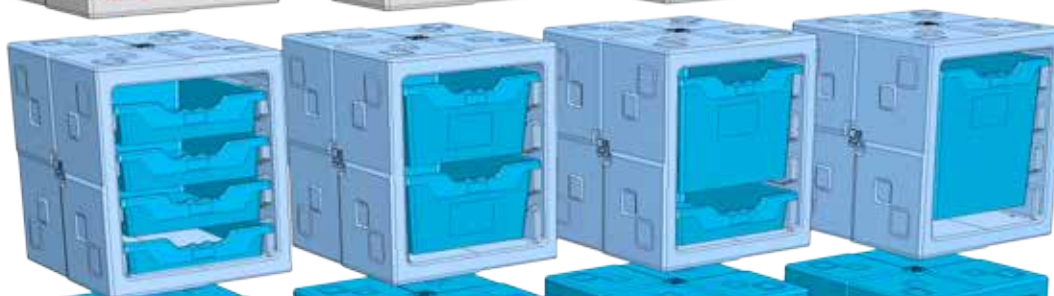

Cubeau Azzurro P278C
Vaschetta Blu RAL 5017
*Cubeau Light blue P278C
Tray Blue RAL 5017*

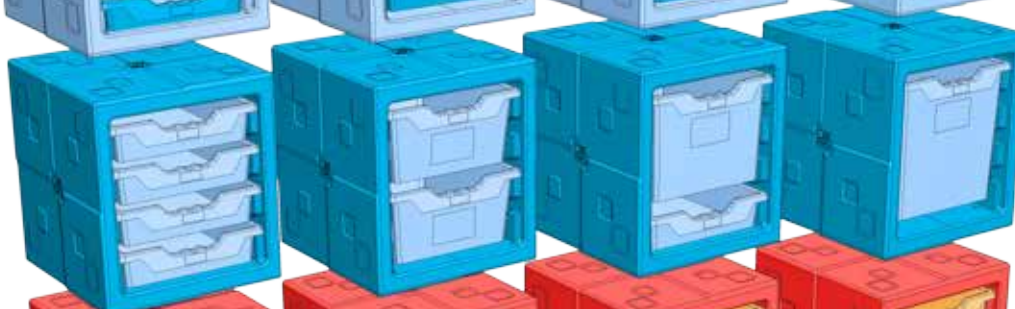

Cubeau Blu RAL 5017
Vaschetta Azzurro P278C
*Cubeau Blue RAL 5017
Tray Light blue P278C*



Cubeau Rosso RAL 3002
Vaschetta Arancio P157C
*Cubeau Red RAL 3002
Tray Orange P157C*



Cubeau Giallo RAL 1021
Vaschetta Verde RAL 6001
*Cubeau Yellow RAL 1021
Tray Green RAL 6001*

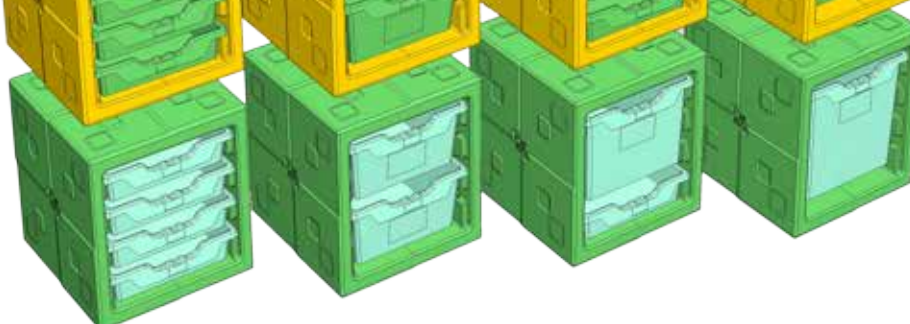

Cubeau Verde RAL 6001
Vaschetta Verde P337C
*Cubeau Green RAL 6001
Tray Green P337C*





BEAU





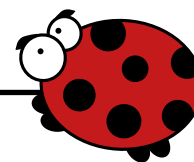

VASCHETTA PORTAOGGETTI / TRAY

COLORI DISPONIBILI
AVAILABLE COLOURS



h. 7,5



Art. OM 4.0497
VASCHETTA H. 7,5
TRAY H. 7,5
polipropilene / polypropilene
Dim. cm. 37,5 x 31 x 7,5 h

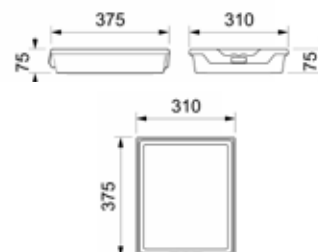

h. 15,5



Art. OM 4.0496
VASCHETTA H. 15,5
TRAY H. 15,5
polipropilene / polypropilene
Dim. cm. 37,5 x 31 x 15,5 h

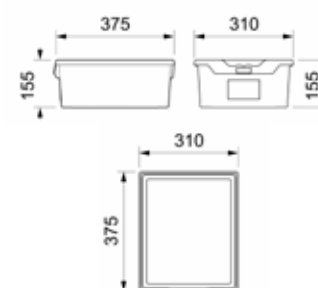

h. 22,5



Art. OM 4.0499
VASCHETTA H. 22,5
TRAY H. 22,5
polipropilene / polypropilene
Dim. cm. 37,5 x 31 x 22,5 h

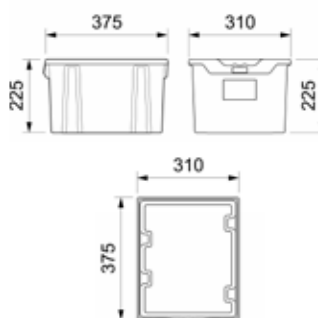

h. 30



Art. OM 4.0498
VASCHETTA H. 30
TRAY H. 30
polipropilene / polypropilene
Dim. cm. 37,5 x 31 x 30 h

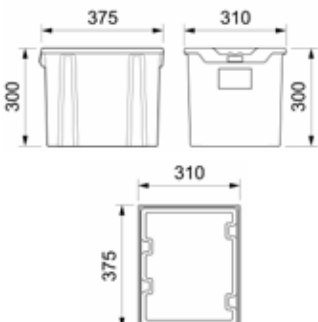

Le vaschette con altezza 22,5 e 30 cm hanno la possibilità sia di essere impilate che sovrapposte.
Omsi tray height 22,50 and 30 cm can be either stacked and overlapped.



h. 15,5 ANGOLARE / ANGULAR



Art. OM 4.0500
VASCHETTA ANGOLARE
ANGULAR TRAY
polipropilene / polypropilene
Dim. cm. 37,5 x 37,5 x 15,5 h

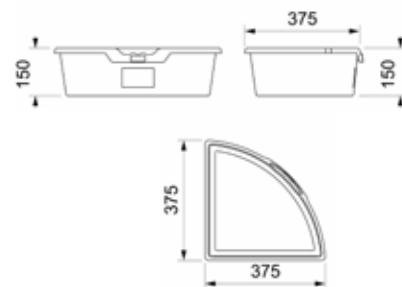

Art. OM 4.0503
COPERCHIO VASCHETTA
COVER TRAY
polipropilene trasparente
transparent polypropilene



Possibilità di personalizzazione con logo.
Esempio: Comune di Bologna
Customized logo personalizations are also available:
I.E. Municipality of Bologna



Art. OM 4.0501
Guida per vaschetta portaoggetti
Slide guide for tray holder
Colore nero (n.2 pz. per ogni vaschetta)
Black color (n.2 pcs. each tray)



Art. OM 4.0502
Guida per vaschetta portaoggetti con sistema di blocco
Slide guide for tray holder with back stop
Colore nero (n.2 pz. per ogni vaschetta)
Black color (n.2 pcs. each tray)

Art. OM 4.0504
RUOTE / WHEELS
Possibilità di 4 ruote
diametro 4 cm
Altezza totale (con ruote) 34 cm.
*It can be equipped with 4 wheels
4 cm diameter, total size 34 cm.*



La particolare configurazione delle nuove guide di sicurezza con sistema di blocco fanno sì che la vaschetta per essere estratta debba essere leggermente sollevata (fig. 3)

The backstop system on the sliding guides does not enable the extraction of the trays unless they're slightly raised (Fig. 3)



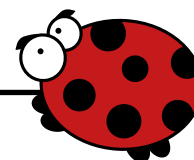

ARMADIO PORTAVASCHETTE STORAGE UNIT

Armadio modulare con struttura in truciolare nobilitato Cat. 1
Normativa Europea EN 717 e EN 120
ripiani spostabili, ante battenti in ABS
spessore 3 mm. Possibilità di applicazione
di ante di chiusura in colori pastello del
medesimo materiale, in diverse forme
e configurazioni a seconda delle esigenze.

*Modular cabinet, chipboard structure Cat. 1
European Standard EN717 and EN 120.
Movable shelves, ABS swinging doors, 3 mm
thick. Cabinet doors eventually available in
pastel colors, of the same material,
in different shapes and configurations
depending on needs.*

Art. OM 4.1488

Z10 - Armadio porta vaschette basso
Small storage unit
Dim. cm 115 x 100 h x 40

Art. OM 4.1489

Z20 - Armadio porta vaschette alto
High storage unit
Dim. cm 115 x 162 h x 40





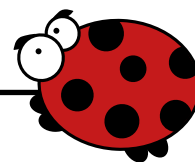

518

Certificata
EN 1729
Tested to
comply with
EN 1729

COLORI
DISPONIBILI
AVAILABLE
COLOURS



LE CONFEZIONI IN SCATOLE DA 4 PZ.
COMPREDONO LE DUE GRANDEZZE DI PIEDI
KITS IN BOXES OF 4 PCS.
INCLUDE TWO SIZES OF FEET

Art. OM 4.326

1 2

Seggiolina plastica / Baby plastic chair

Dim. cm. 32 x 27 x 48

Piano seduta / Seat height h cm. 26/31

Tutte le seggioline vengono fornite con
piedi di doppia grandezza

All the little chairs are supplied with
complete set of caps.

grandezza 1
size 1



grandezza 2
size 2

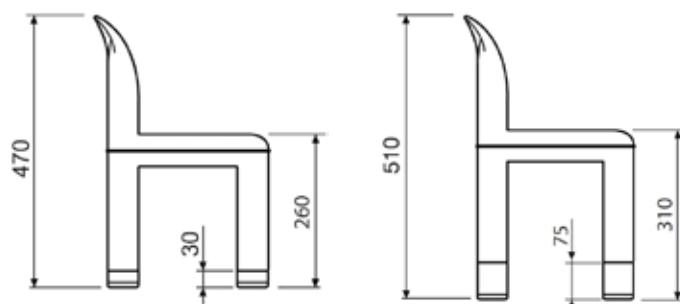



La seggiolina **S18** è realizzata in polipropilene, particolarmente robusta, arrotondata, lavabile e inattaccabile dagli acidi. La scocca anatomica rende la posizione di seduta corretta e riposante. La seggiolina può essere modificata in altezza con una semplice sostituzione dei tappi inferiori.

S18 chair is made of polypropylene, particularly strong, rounded, washable and resistant to acids. The anatomical shell enables a correct and restful seating posture. The height of the chair can be adjusted with a simple replacement of the lower caps.



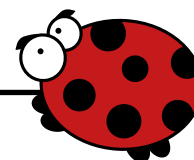

S20

COLORI
DISPONIBILI
AVAILABLE
COLOURS



Certificata
EN 1729 1-2
Tested to
comply with
EN 1729 1-2

Art. OM 4.370

1

Seduta S20 polipropilene

Chair S20 polypropilene

con telaio in metallo grandezza 1 a 4 gambe

with 4 legs metal frame size 1

Dim. 28,5 x 30 x 52 h x 26 h

Art. OM 4.371

2

Seduta S20 polipropilene

Chair S20 polypropilene

con telaio in metallo grandezza 2 a 4 gambe

with 4 legs metal frame size 2

Dim. 28,5 x 30 x 57 h x 31 h

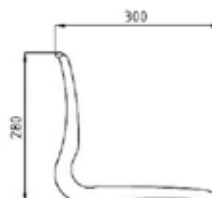
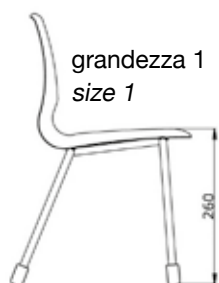

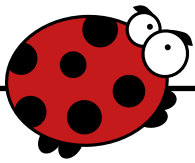

S30 - S40

SEDIA IN PP SU TELAIO A 4 GAMBE
CHAIR IN PP 4 LEGS METAL FRAME



GRANDEZZA 6
SIZE 6

GRANDEZZA 5
SIZE 5

GRANDEZZA 4
SIZE 4

GRANDEZZA 3
SIZE 3

GRANDEZZA 2
SIZE 2

GRANDEZZA 1
SIZE 1



S30

3 4

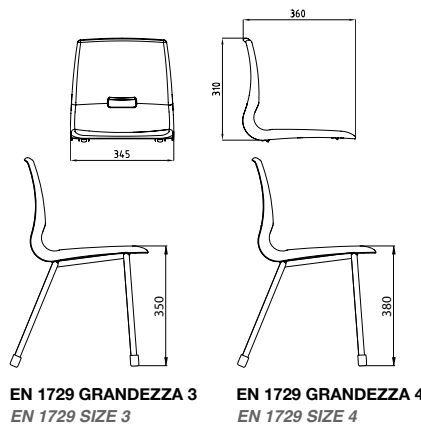

EN 1729 GRANDEZZA 3
EN 1729 SIZE 3

EN 1729 GRANDEZZA 4
EN 1729 SIZE 4

Art. OM 4.372

3

Seduta S30 polipropilene
Chair S30 polypropilene
con telaio in metallo grandezza 3 a 4 gambe
with 4 legs metal frame size 3
Dim. 35 x 36 x 66 h x 35 h

Art. OM 4.373

4

Seduta S30 polipropilene
Chair S30 polypropilene
con telaio in metallo grandezza 4 a 4 gambe
with 4 legs metal frame size 4
Dim. 35 x 36 x 69 h x 38 h



S40

5 6

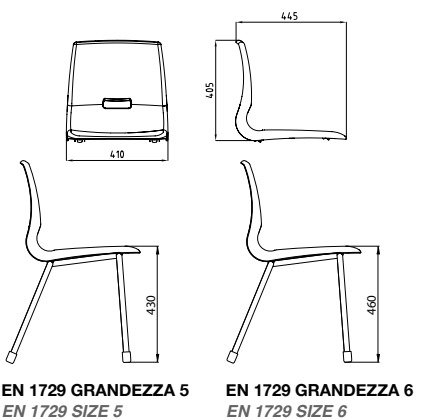

EN 1729 GRANDEZZA 5
EN 1729 SIZE 5

EN 1729 GRANDEZZA 6
EN 1729 SIZE 6

Art. OM 4.374

5

Seduta S40 polipropilene
Chair S40 polypropilene
con telaio in metallo grandezza 5 a 4 gambe
with 4 legs metal frame size 5
Dim. 42 x 46 x 77 h x 43 h

Art. OM 4.375

6

Seduta S40 polipropilene
Chair S40 polypropilene
con telaio in metallo grandezza 6 a 4 gambe
with 4 legs metal frame size 6
Dim. 42 x 46 x 80 h x 46 h

Certificata
EN 1729 1-2
Tested to
comply with
EN 1729 1-2

COLORI
DISPONIBILI
AVAILABLE
COLOURS







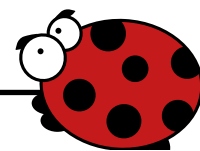

B18

TAVOLO SAGOMATO SHAPED TABLE

TAVOLO SAGOMATO
QUADRATO - 4 POSTI
SHAPED SQUARE TABLE
FOR 4 PEOPLE

Art. OM 4.600

Dim. cm. 65 x 65 x 46/52 h

I tavoli particolarmente sicuri, presentano una struttura con ripiano in bilaminato dai bordi in plastica arrotondati e dotata di gambe in polipropilene, smontabili agevolmente. Il tavolo, può essere modificato in altezza con una semplice sostituzione dei tappi inferiori.

The particularly safe tables, have a structure with laminated top with plastic rounded edges and polypropilene legs, easily removable. The height of the table can be adjusted with a simple replacement of the lower caps.

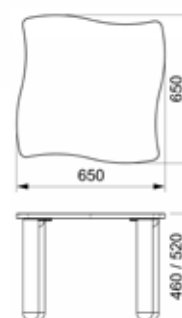

TAVOLO SAGOMATO
RETTANGOLARE - 6 POSTI
SHAPED RECTANGULAR TABLE
FOR 6 PEOPLE

Art. OM 4.601

Dim. cm. 130 x 65 x 46/52 h

COLORI
DISPONIBILI
AVAILABLE
COLOURS



Esempi di composizioni
Examples of compositions

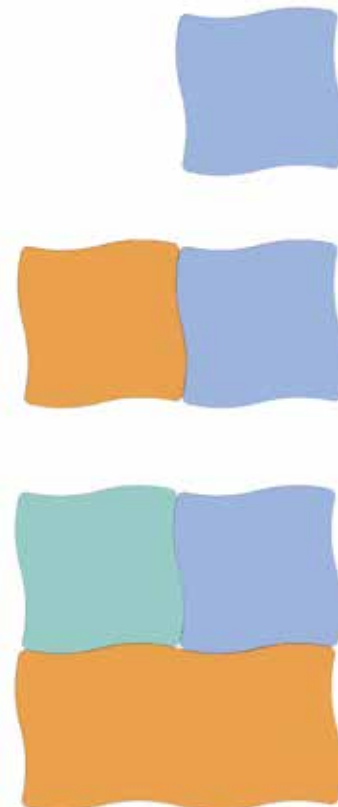
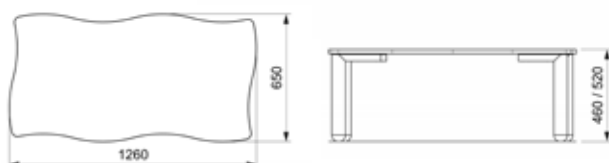



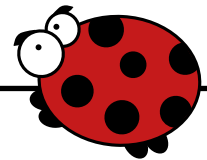

TAVOLO SAGOMATO
TRAPEZIO - 5 POSTI
TRAPEZOIDAL SHAPED TABLE
FOR 5 PEOPLE

Art. OM 4.602

Dim. cm. 120 x 60 x 46/52 h



COLORI
DISPONIBILI
AVAILABLE
COLOURS

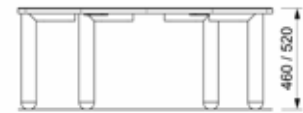
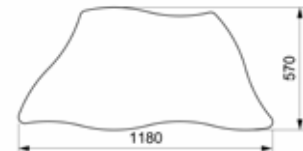

Esempi di composizioni
Examples of compositions

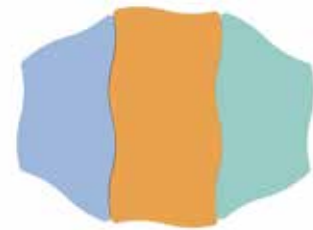

TAVOLO SAGOMATO
ESAGONALE - 6 POSTI
EXAGONAL SHAPED TABLE
FOR 6 PEOPLE

Art. OM 4.603

Dim. cm. 120 x 110 x 46/52 h

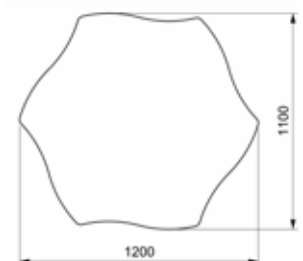



B18

TAVOLO QUADRATO E RETTANGOLARE
SQUARE AND RECTANGULAR TABLE



ART. OM 4.327

TAVOLO 4 - Quadrato 4 posti
TABLE 4 - Square for 4 people
Dim. cm. 65 x 65 - h cm. 46/52

Art. OM 4.329

TAVOLO 6 - Rettangolare 6 posti
TABLE 6 - Rectangular for 6 people
Dim. cm. 130 x 65 - h cm. 46/52

Certificato
EN 1729 1-2
Tested to
comply with
EN 1729 1-2

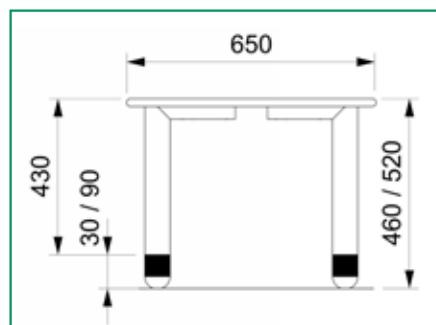

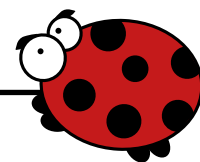

ATTACCAPANNI CON GANCIO OVALE
 OVAL CLOTHES-HOOK PANEL



ATTACCAPANNI OVALE A MURO / OVAL WALL CLOTHES-HOOK

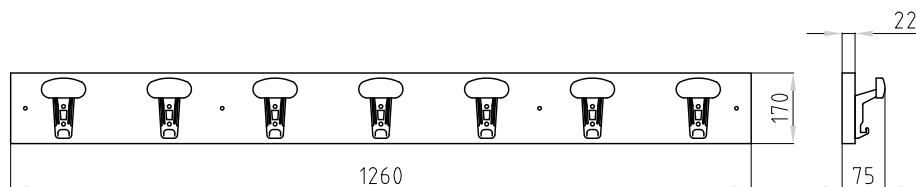

Art. OM 4.384
 Attaccapanni 7 posti
 Clothes-hook 7 places

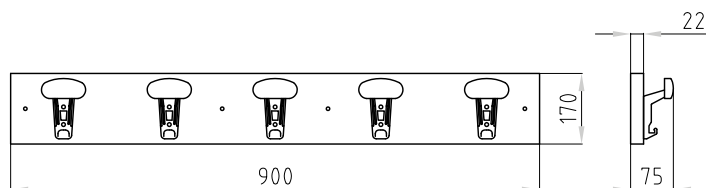

Art. OM 4.383
 Attaccapanni 5 posti
 Clothes-hook 5 places

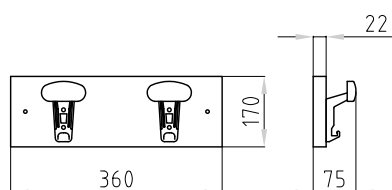

Art. OM 4.382
 Attaccapanni 2 posti
 Clothes-hook 2 places

COLORI
 DISPONIBILI
 AVAILABLE
 COLOURS

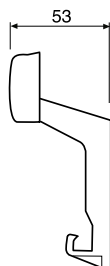
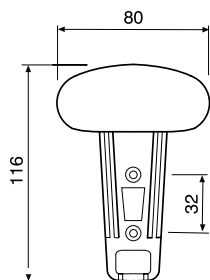

ATO072





ATTACCAPANNI CON APPENDINO GIREVOLE CON 1 O 2 AGGANCI SINGLE/DOUBLE SWIVEL CLOTHES-HOOK



COLORI DISPONIBILI
AVAILABLE COLOURS

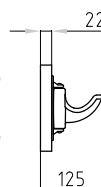
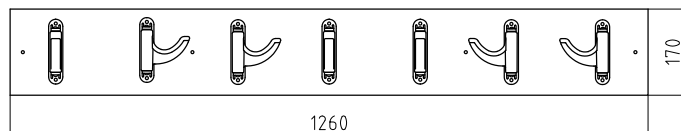

Art. OM 4.390
Attaccapanni 7 posti
Clothes-hook 7 places

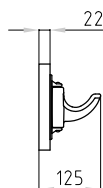
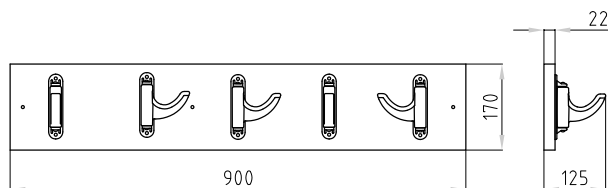

Art. OM 4.389
Attaccapanni 5 posti
Clothes-hook 5 places

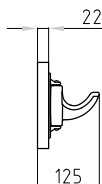
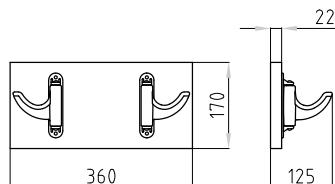

Art. OM 4.388
Attaccapanni 2 posti
Clothes-hook 2 places

Determinazione della portata con carico di compressione PT
GANCIO SUPERIORE:
carico massimo N 2.400
GANCIO INFERIORE:
carico massimo N 1.200

Determination of the loading capacity with pressure load PT
UPPER HOOK:
maximum load 2.400 N
LOWER HOOK:
maximum load 1.200 N

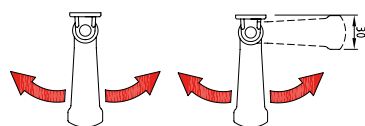

ATO081
APPENDINO GIREVOLE
1 AGGANCI
SWIVEL CLOTHES HOOK
SINGLE



ATO082
APPENDINO GIREVOLE
2 AGGANCI
SWIVEL CLOTHES HOOK
DOUBLE

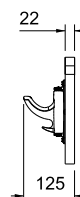
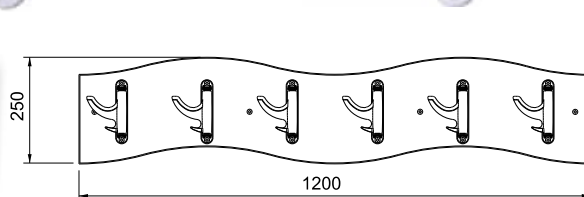

Per entrambi gli appendini possibilità di montaggio su pannello rettangolare o sagomato
Both models are suitable to be assembled on to shaped or rectangular wooden panel.

Art. OM 4.391
Attaccapanni sagomato 6 posti
Shaped Clothes-hook 6 places

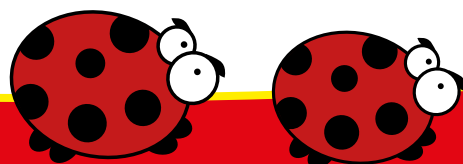

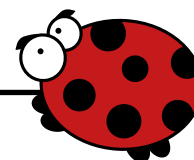

Art. OM 4.357

Brandina nido / Kids bed

Dim. cm. 130 x 56 x 12

impilabile - Fornita montata

Stackable - Supplied assembled

Certificata
EN 716-2:1995
Tested to
comply with
EN 716-2:1995



Art. OM 4.334

Carrello portabrandina / Kids bed trolley

Dim. cm. 130 x 56 x 19

Realizzato in tubolare metallico verniciato e corredato di 4 ruote piroettanti molto robuste e frenanti. Consente di impilare e spostare fino a 15 brandine.

Made of painted metal tube and equipped with 4 very robust brake castors to stack and move up to 15 cots.

Art. OM 4.359

Lenzuolino - conf. 4 pz.

Telo di copertura in cotone

Lavabile in lavatrice

Bedsheet - 4 pcs. box

100% cotton / Machine washable

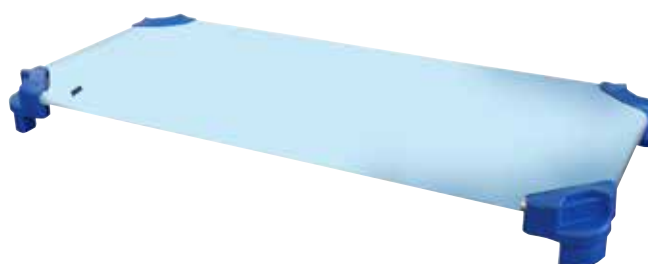

Piede brandina nido / Kid's bed foot
PP ignifugo
Cl. 1 Colore blu RAL 5017
Fire retardant C1 blue RAL5017





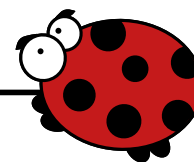

PARACOLPI / SOFT BUMPERS



ART. OM 4.445

PARACOLPI / SOFT BUMPERS

Ideali per proteggere svariate situazioni pericolose come muri di recinzione, colonne, tubi, pilastri, cordoli e pali, sia in ambienti esterni che interni come centri sportivi, palestre e scuole.

Realizzabili in qualsiasi forma e dimensione, hanno un elevato grado di assorbimento urti e sono in grado di ridurre gli incidenti e le lesioni grazie al poliuretano utilizzato per interno con densità 21 e con spessore di 4/6 cm. Tutti i prodotti sono forniti su misura in base alle esigenze del cliente. Installazione molto semplice, mediante fascia in velcro.

Ideal as a protection against various hazardous situations such as fencing walls, columns, tubes, pillars, curbs and poles, both in outdoor and indoor environments such as sports centers, gyms and schools. Available in any shape and size, they have a high degree of shock absorption and are able to reduce accidents and injuries thanks to the polyurethane used for interiors with density 21 and with a thickness of 4/6 cm. All the products are tailored to your needs. Very simple installation with velcro strap.



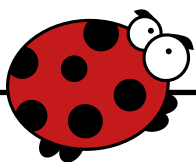

PROTEZIONI MURALI / WALL PROTECTIONS



Con rivestimento in tessuto Green Cover
Covered with Green Cover fabric

Art. OM 4.443

PROTEZIONI MURALI CON DECORAZIONI
WALL PROTECTIONS WITH DECORATIONS

Decorazioni: 2 pesci e 2 specchi
Decorations: 2 fishes, 2 mirrors
Dimensione / size cm 100 x 130 h.

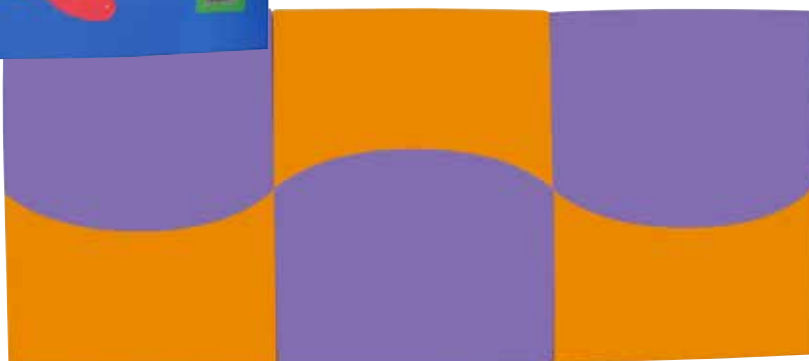

Art. OM 4.444

PROTEZIONI MURALI BICOLORE / WALL PROTECTIONS BICOLORED
Dimensione / size cm 100 x 130 h.

Ideali per la protezione dei muri nelle zone di gioco. Le protezioni murali hanno un forte assorbimento dei colpi e permettono di ridurre gli incidenti e i traumi grazie ad uno spessore di 4 cm.
Ancoraggio al muro tramite bande di velcro da 5 cm di spessore.

*Ideal for wall protection in playground areas. Wall protections have a strong absorption of shocks and allow to reduce the risk of accidents and trauma thanks to their 4 cm thickness.
Wall anchoring by means of 5 cm thick velcro bands*



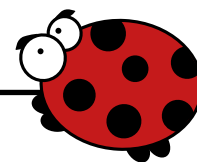

PROTEZIONI MURALI / WALL PROTECTIONS

Con rivestimento in tessuto plastico monosplamato / Covered with Spread plastic fabric



ANCORAGGIO

Le protezioni murali vengono ancorate al muro con doppie fasce di velcro da 5 cm poste nella parte posteriore in alto ed in basso. Il velcro maschio viene fornito a parte da applicare sul muro. E' consigliato l'utilizzo eventuale di listelli di legno (non compresi) sui quali applicare il velcro maschio con colla.

ANCHORAGE

Wall protections are anchored to the wall by means of double velcro bands of 5 cm applied at the back top and bottom part. Male velcro is supplied separately to be applied on the wall. It is advisable to eventually use wooden strips (not included) to fix on the wall onto which Velcro male bands can be glued.

COLORI

Le protezioni sono disponibili in 4 colori: Rosso - Blu - Verde - Giallo

COLOURS

The protections are available in 4 colors: Red - Blue - Green - Yellow

PREZZI

La protezione viene fornita su misura a metro lineare. Il prezzo minimo è pari a 1 mt l.

PRICES

Protection is supplied tailor-cut per linear meter. Minimum price is equal to 1 l. m.

Art. OM 4.440

Protezione murale h 80

Wall protection h 80

Spessore cm. 4 / Thickness cm. 4

Prezzo al metro lineare

Price per linear mt

Art. OM 4.441

Protezione murale h 120

Wall protection h 120

Spessore cm. 4 / Thickness cm. 4

Prezzo al metro lineare

Price per linear mt

Art. OM 4.442

Protezione murale h 160

Wall protection h 160

Spessore cm. 4 / Thickness cm. 4

Prezzo al metro lineare

Price per linear mt



INFORMAZIONI TECNICHE LINEA NIDO E LINEA MATERNA

INTERNI

La maggioranza degli articoli sono realizzati con interni in poliuretano espanso di densità 25 kg. al mc. I materassini di spessore cm. 4 e 6, le forme geometriche e le protezioni murali sono di densità 21 kg al mc. Per i materassi di spessore cm. 10 e 20 viene utilizzato del poliuretano espanso di densità 18 kg. al mc. Tutte le piscine sono realizzate con interno D28 con alta portata. I pouf ed i cuscini sono imbottiti con fibra di poliestere espanso. Su richiesta, tutti gli articoli possono essere forniti con interno in poliuretano espanso ignifugo di densità 25 kg. al mc. (richiedere quotazioni)

RIVESTIMENTI ED ACCESSORI

Con il nuovo programma Soft sviluppato in azienda nel 2016 tutti i rivestimenti impiegati sia per la Linea Nido che per la Linea Materna, **ad esclusione dei materassi e delle protezioni murali mantenuti con tessuto plastico monospalmato per motivi di resistenza**, sono realizzati con il nuovo ecotessuto in poliestere denominato Green cover, elastico, morbido al tatto, antiscivolo, impermeabile, antiabrasivo, resistente alle lacerazioni, lavabile, privo di ftalati ed ignifugo in classe 1IM.

Le fodere per i materassi e le protezioni murali sono realizzate con tessuto plastico monospalmato, opaco, particolarmente resistente alle abrasioni e lacerazioni, lavabile, atossico, ignifugo in classe 2 e privo di ftalati. Su richiesta possono essere forniti con tessuto Green cover. (richiedere quotazioni). I pouf ed i cuscini sono dotati di doppia fodera, una interna bianca ed una esterna colorata. Tutti i rivestimenti sono dotati di chiusure lampo particolarmente robuste, che ne consentono la sostituzione nel tempo, con cursori a scomparsa in apposite taschine. Le fasce di velcro impiegate, da cm. 5, per ancorare percorsi, piscine e protezioni sono di ottima qualità e particolarmente resistenti.

COLORI

Con la nuova produzione 2016 siamo in grado di soddisfare molte esigenze del mercato offrendo una gamma colori particolarmente ricca e piacevole. In particolare il tessuto Green cover prevede un assortimento di 11 colori dei quali 4 tenui già utilizzati per la linea nido e 7 più vivaci utilizzati per i nuovi articoli della linea materna. Su richiesta del cliente comunque ogni articolo esposto in catalogo, sia della linea nido che materna, può essere fornito con colore diverso da selezionare sulla vasta gamma di 11 proposti. Gli articoli realizzati con rivestimenti bicolore, comprese le sedute per bambini, vengono forniti in base alle foto esposte in catalogo. Su richiesta possono essere forniti con combinazioni di colore scelti dal cliente. Le fodere relative ai materassi e protezioni, realizzate con tessuto plastico monospalmato, sono disponibili nei 4 colori tradizionali: rosso - blu - giallo - verde.

REQUISITI DI SICUREZZA

L'azienda Omsi, responsabile della progettazione, produzione e confezionamento degli articoli contenuti nel presente catalogo Soft, garantisce che i prodotti sono realizzati nel pieno rispetto delle norme europee previste in termini di qualità e sicurezza.

TECHNICAL INFORMATION ABOUT NURSERY AND KINDERGARTEN SOFT COLLECTIONS

INTERIORS

Most of the products are made with polyurethane foam interiors density 25 kg. per cubic meter. The 4 and 6 cm-thick mattresses., the geometric shapes and the wall protections are density 21kg per cubic meter. For mattresses of 10 and 20 cm thickness, it is used polyurethane foam density 18 kg. per cubic meter. The poufs and cushions are filled with expanded polyester fiber. Upon request, all items can be supplied with fire retardant polyurethane foam 25 kg density per cubic meter. (Ask for quotes)

FABRICS AND ACCESSORIES

With the new Soft program developed by OMSI in 2016 all fabrics used for both Nursery and Kindergarten Soft Collections, excluding mattresses and wall protections for which we use single spread plastic fabric for strength reasons, are made with the new eco polyester fabric called Green cover, elastic, soft to the touch, non-slip, waterproof, abrasion-resistant, tear-resistant, washable, phthalate-free and fire-retardant class 1 IM.

The covers for mattresses and wall protections are realized with single spread plastic fabric, matte, particularly resistant to abrasion and tearing, washable, non-toxic, fire retardant class 2 and phthalate-free. On request they can be supplied with Green cover fabric. (Ask for quotes). Poufs and pillows are equipped with double lining, a white internal one and a colorful exterior. All fabrics have particularly robust zippers, that can be replaced, with sliders retractable in appropriate pockets. The used Velcro straps, cm. 5, to anchor paths, pools and protections are of excellent quality and very resistant.

COLOURS

With the new production in 2016 we are able to comply with market requirements, offering a wide range of different colors. In particular, the fabric cover Green provides a selection of 11 colors of which 4 pastel colors already used in the nursery line and 7 bright colors used for new articles of the kindergarten line. Upon request of the customer, in any case, each item displayed in the catalog both of the nursery and kindergarten collections, can be supplied with different colors to be selected among the 11 proposed. Products displayed with two-tone finishes, including kid's sofas, are usually supplied according to the photos shown in the catalog. Upon request, they can be supplied with color combinations chosen by the customer. Fabrics of mattresses and protections, made with single spread plastic fabric, are available in the 4 traditional colors: red - blue - yellow - green.

SAFETY REQUIREMENTS

Omsi srl, responsible for the design, manufacture and packaging of the products displayed in this Soft catalog guarantees that the same are manufactured in full compliance with European regulations in terms of quality and safety.

GAMMA COLORI LINEA NIDO / COLOUR RANGE NURSERY LINE

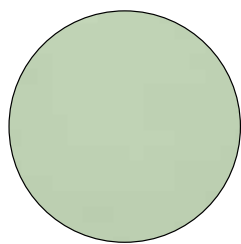

GREEN COVER
VERDE ACQUA
WATER GREEN

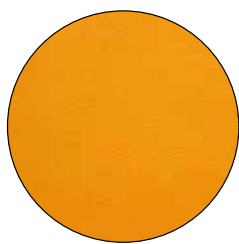

GREEN COVER
ARANCIO
ORANGE

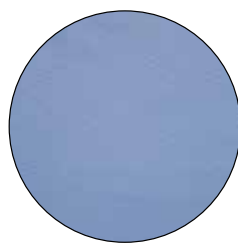

GREEN COVER
AZZURRO
BABY BLUE

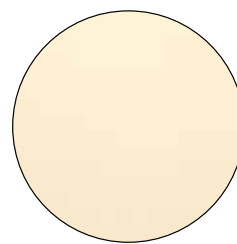

GREEN COVER
PANNA
CREAM

GAMMA COLORI LINEA MATERNA / COLOUR RANGE KINDERGARDEN LINE

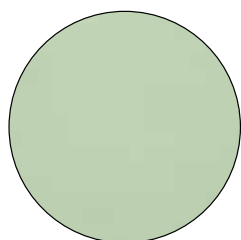

GREEN COVER
VERDE ACQUA
WATER GREEN

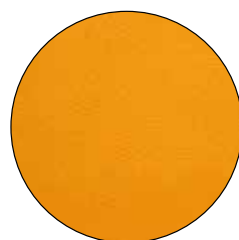

GREEN COVER
ARANCIO
ORANGE

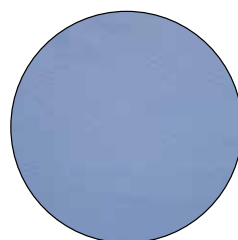

GREEN COVER
AZZURRO
BABY BLUE

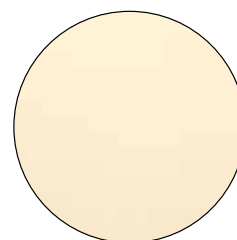

GREEN COVER
PANNA
CREAM

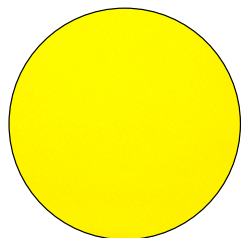

GREEN COVER
GIALLO
YELLOW

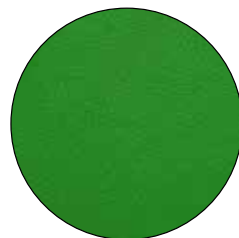

GREEN COVER
VERDE BRILLANTE
DARK GREEN

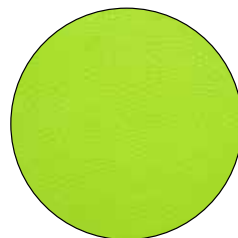

GREEN COVER
VERDE CHIARO
LIGHT GREEN

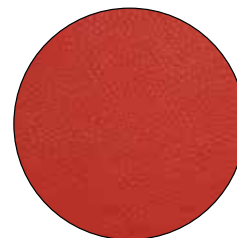

GREEN COVER
ROSSO
RED

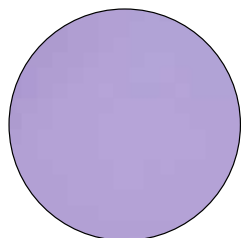

GREEN COVER
LILLA
LILAC



GREEN COVER
VIOLA
PURPLE



GREEN COVER
BLU
BLUE

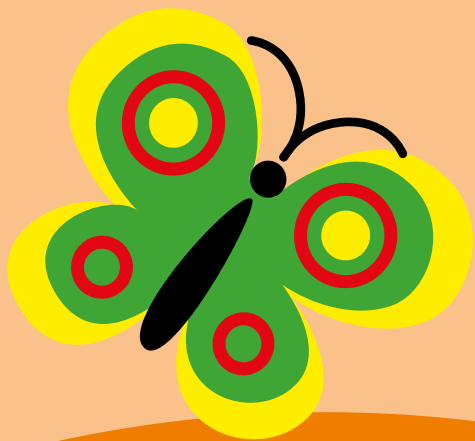

Linea materna KINDERGARTEN LINE



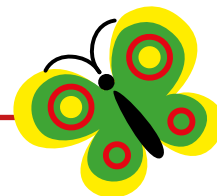

GIOCHI DI MOVIMENTO A DONDOLO MOTORY ROCKING TOYS

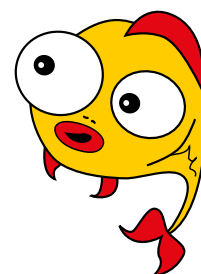
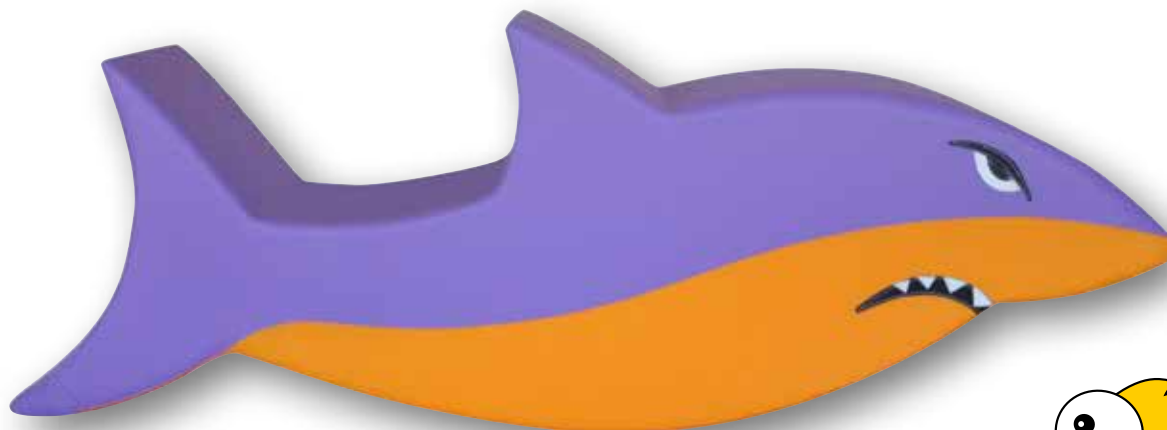

ART. OM 2.062

PESCE CANE / SHARK

Elementi di gioco / arredo stabili e sicuri, possono essere utilizzati sia come cavalcabili che come sedute. Le forme, i colori impiegati nei rivestimenti e i particolari inseriti, aiutano il bambino a stimolare l'immaginazione. Disponibile in due abbinamenti di colore.

Dimensione: cm 120 x 25 x 45 h - Altezza di seduta 25 cm

These play / furniture items are stable and safe and can be used both as a rideable elements and as a seat. The shapes, the colors used in the coverings and the details inserted, help the baby to stimulate the imagination, available in two color combinations.

Size: cm 120 x 25 x 45 h - Seat height 25 cm

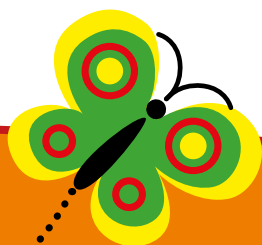
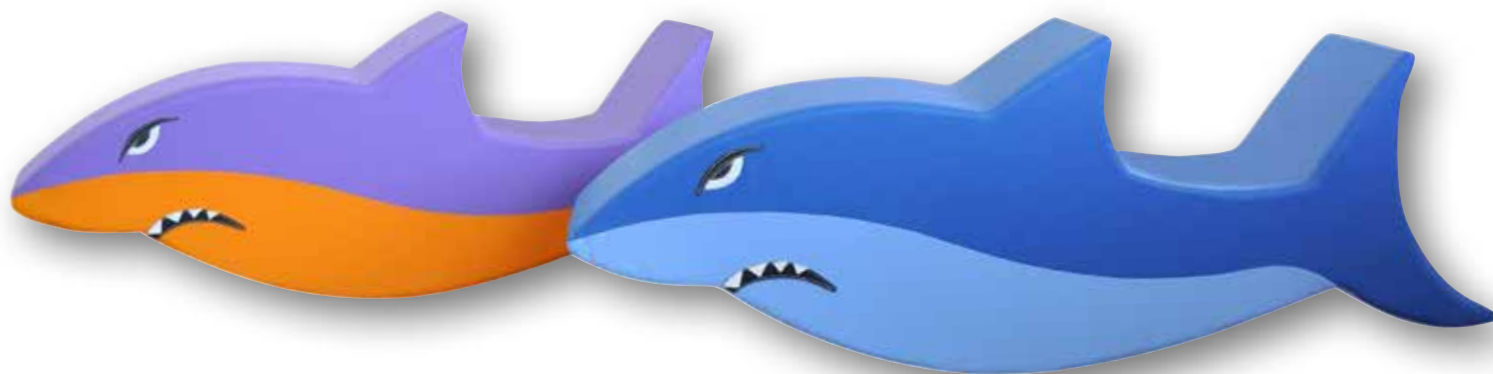

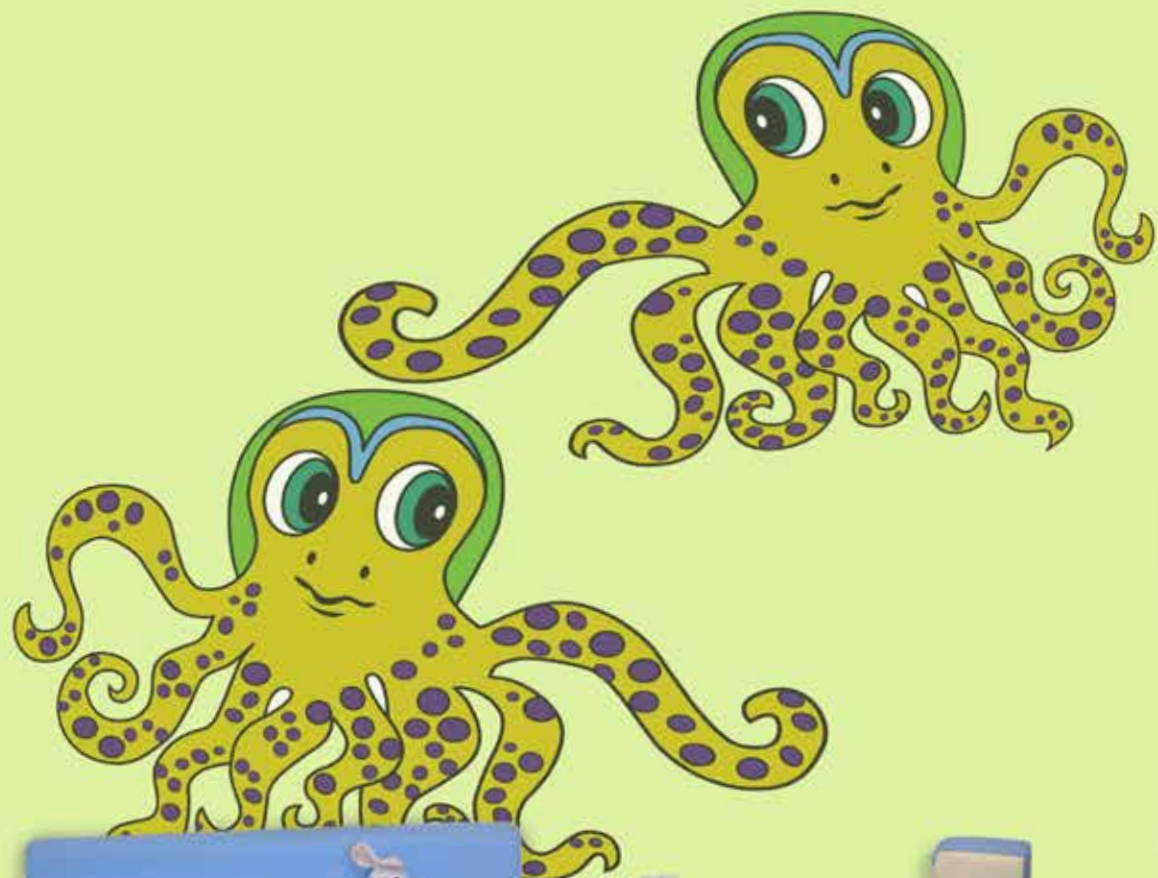

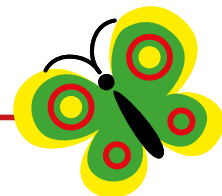

GIOCHI DI MOVIMENTO A DONDOLO MOTORY ROCKING TOYS

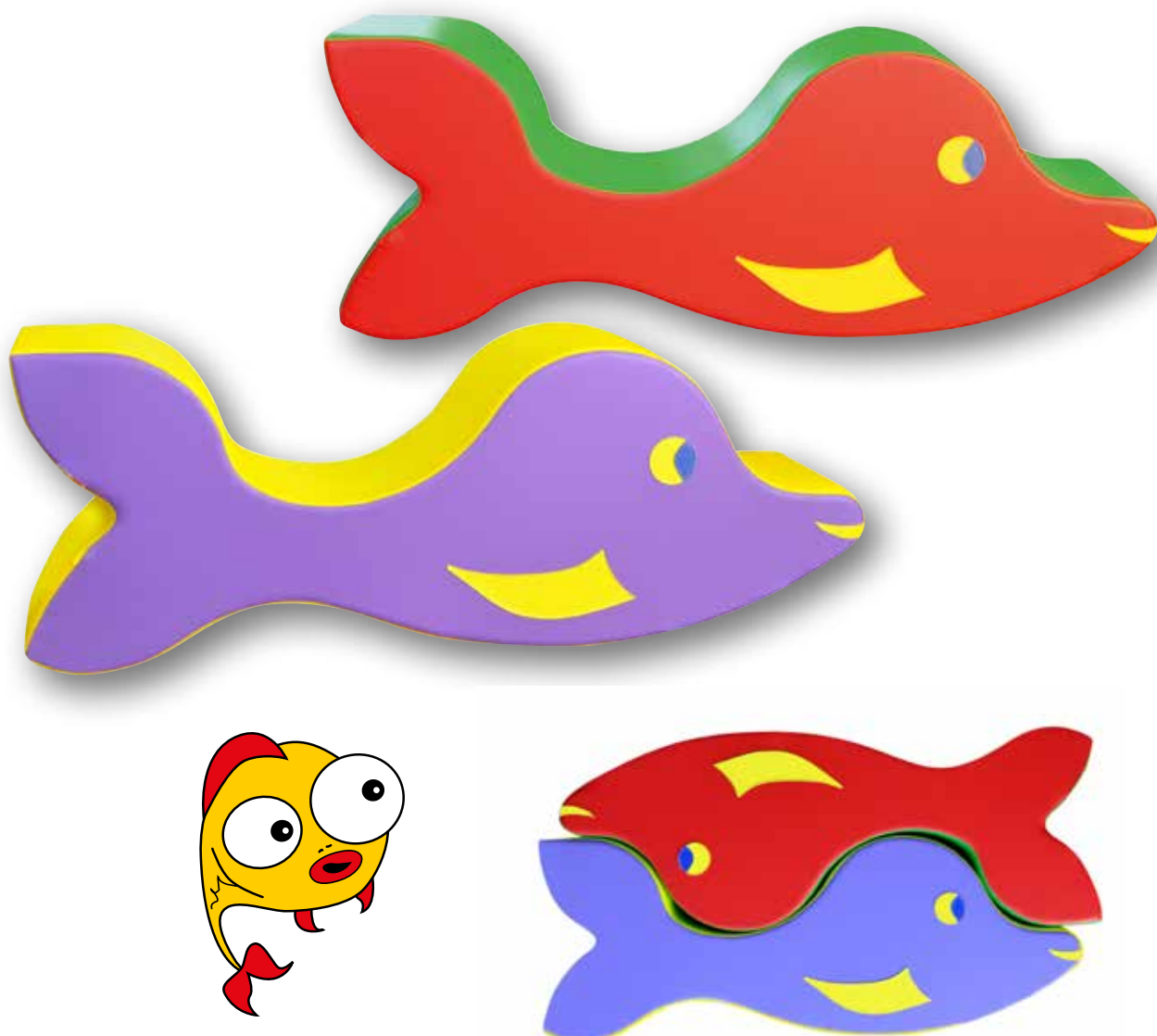

ART. OM 2.060

PESCE DONDOLO / ROCKING FISH

Elementi di gioco / arredo stabili e sicuri, possono essere utilizzati sia come cavalcabili che come sedute. Le forme, i colori impiegati nei rivestimenti e i particolari inseriti, aiutano il bambino a stimolare l'immaginazione. Disponibile in due abbinamenti di colore.

Dimensione: cm 125 x 25 x 45 h - Altezza di seduta 25 cm

These play / furniture items are stable and safe and can be used both as a rideable elements and as a seat. The shapes, the colors used in the coverings and the details inserted, help the baby to stimulate the imagination, available in two color combinations.

Size: cm 125 x 25 x 45 h - Seat height 25 cm

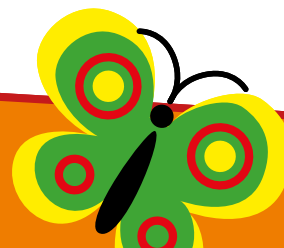
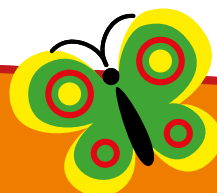
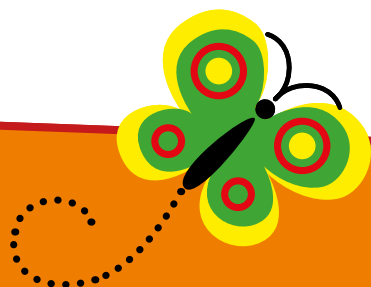

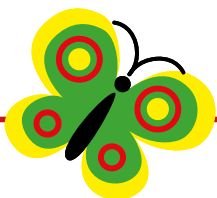

GIOCHI DI MOVIMENTO A DONDOLO MOTORY ROCKING TOYS



ART. OM 2.066

PIOVRA A DONDOLO / *ROCKING OCTOPUS*

Struttura basculante realizzata in densità 28 che la rende un prodotto stabile, sicuro e comodo.

Dimensione: cm 150 x 25 x 65 h - Altezza di seduta 25 cm

Rocking structure - density 28 stable, safe and comfortable.

Size: cm 150 x 25 x 65 h - Seat height 25 cm



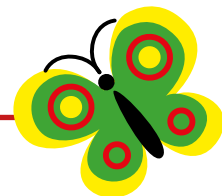

GIOCHI DI MOVIMENTO CAVALCABILI MOTORY RIDING TOYS

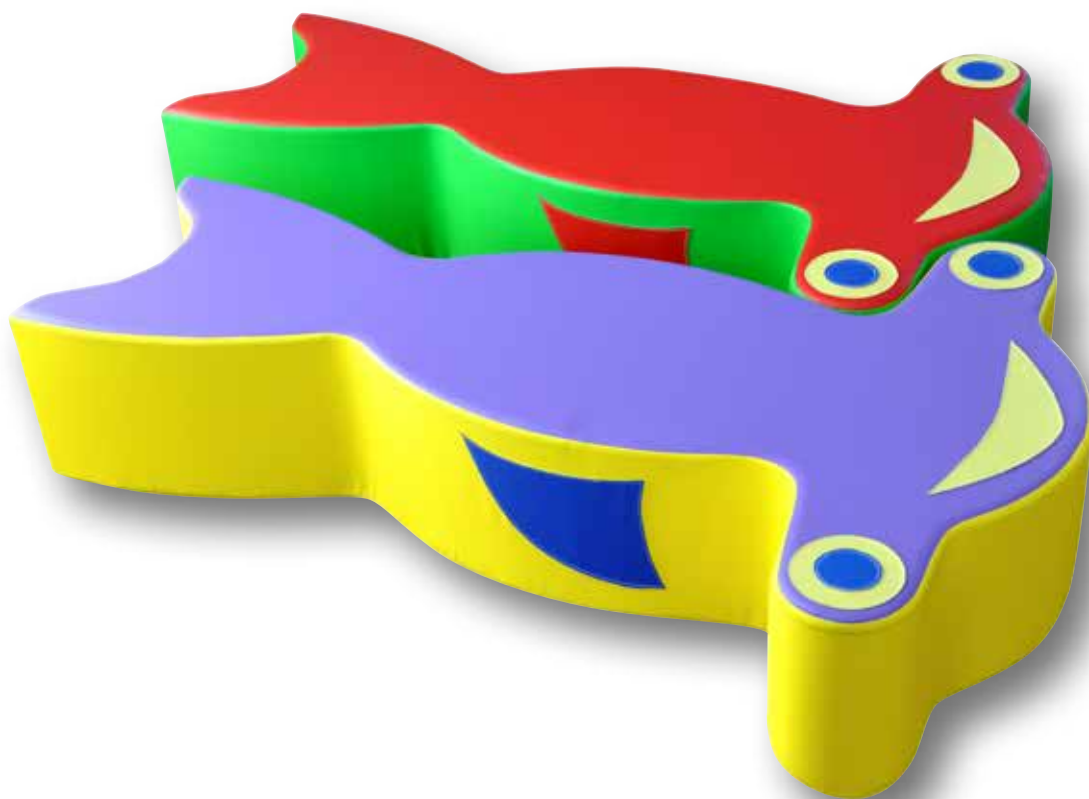

ART. OM 2.061

PESCE MARTELLO / HAMMER FISH

Elementi di gioco / arredo stabili e sicuri, possono essere utilizzati sia come cavalcabili che come sedute. Le forme, i colori impiegati nei rivestimenti e i particolari inseriti, aiutano il bambino a stimolare l'immaginazione. Disponibile in due abbinamenti di colore.

Dimensione: cm 130 x 76 x 25 h - Altezza di seduta 25 cm

These play / furniture items are stable and safe and can be used both as a rideable elements and as a seat. The shapes, the colors used in the coverings and the details inserted, help the baby to stimulate the imagination, available in two color combinations.

Size: cm 130 x 76 x 25 h - Seat height 25 cm

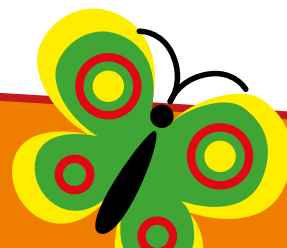
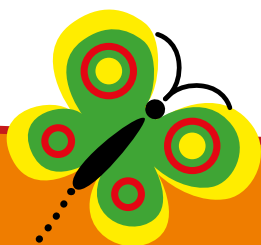
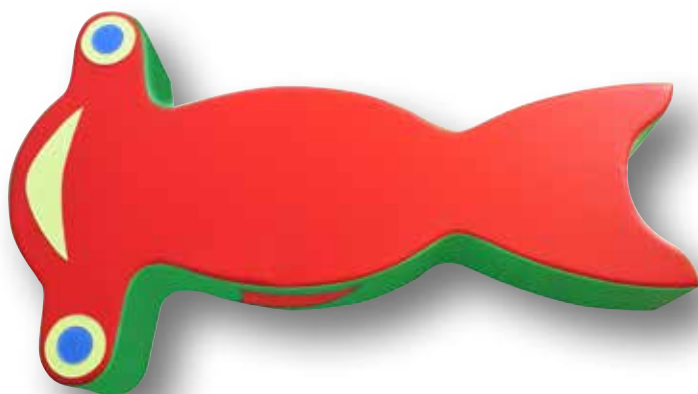



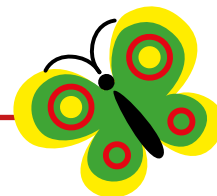

GIOCHI DI MOVIMENTO CAVALCABILI MOTORY RIDING TOYS



ART. OM 2.136

PESCE SARDINA / SARDINE FISH

Kit di 2 pezzi

Kit of 2 pieces

Fantasiosa sagoma a forma di pesce sardina, polifunzionale, può essere utilizzato singolarmente come cavalcabile oppure come pouf per più piccini. Accoppiando ad incastro i due elementi sardina si crea un'area seduta comoda e divertente. Disponibile in 4 colori vivaci.

Dim. cm 105 x 95 x 25 h (singolo elemento)

Dim. cm 110 x 110 x 25 h (confezione di due pezzi ad incastro)

A fanciful multifunctional sardine fish shape infact it can be used individually as a ride or as a pouf for several children.

By combining two sardine elements, a comfortable and fun sitting area is created.

Available in 4 lively colors.

Size: cm 105 x 95 x 25 h (single element) - Size: cm 110 x 110 x 25 h (two-piece packing)

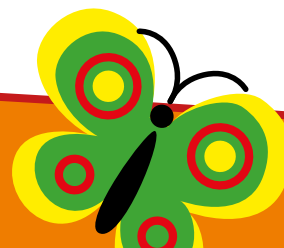

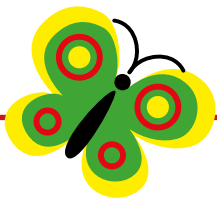

GIOCHI DI MOVIMENTO CAVALCABILI MOTORY RIDING TOYS

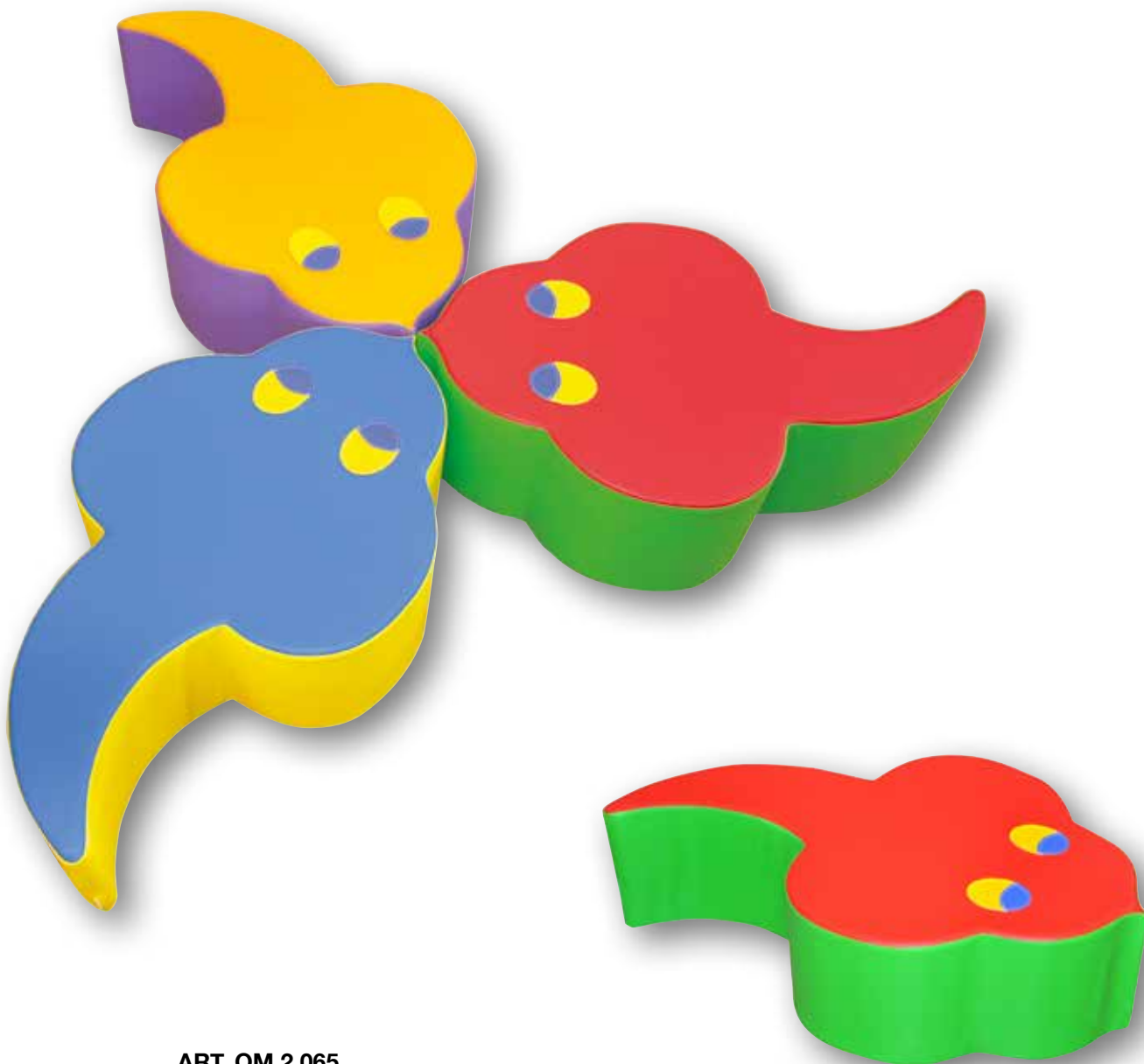

ART. OM 2.065

POUF PESCE RAZZA / SKATE FISH POUF

Simpatico pouf a forma di pesce razza, può essere sia cavalcato che usato come comoda seduta.

Disponibile in assortimento di 3 colori.

Dim.: cm 90 x 55 x 25 h

Pleasant pouf shaped as skate fish, both to be ridden or used as a comfortable seat.

Available in 3 color assortment.

Size: cm 90 x 55 x 25 h

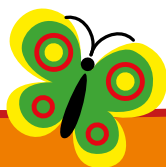



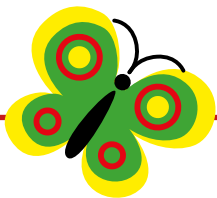

GIOCHI DI MOVIMENTO CAVALCABILI MOTORY RIDING TOYS



ART. OM 2.134

PESCE / FISH

(pezzo unico)

(single piece)

Dim. cm 90 x 25 x 41 h

Altezza seduta 25 cm

Seat height 25 cm



ART. OM 2.135

TRENINO PESCI / FISH TRAIN

Kit di 4 pesci in 4 colori diversi

Dimensione totale: cm 340 x 25 x 41 h

4 fish kit in 4 different colors

Total size: 340 x 25 x 41 h

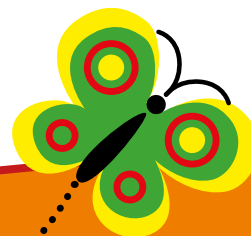
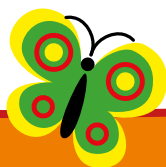
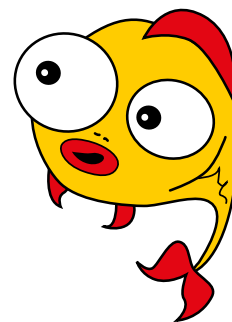

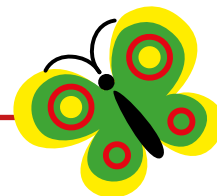

GIOCHI DI MOVIMENTO CAVALCABILI MOTORY RIDING TOYS



Art. OM 2.113

Trenino colorato / *Colored train*

Composizione di 4 elementi cavalcabili, ad altezze differenziate, uniti tra loro da un sistema ad incastro che ne permette l'ancoraggio e l'ampliamento in lunghezza.

Ride Composition of 4 elements, at different heights, joined together by an interlocking system that allows anchoring and expansion in length.

Dimensioni totali / *Total size:*
cm. 320 x 20 x 45 h



Art. OM 2.112

Vagone rosso / *red wagon*

Dim. cm. 95 x 20 x 45 h

Seduta h 23 cm.

Chair h 23 cm.

Art. OM 2.109

Vagone verde / *green wagon*

Dim. cm. 85 x 20 x 40 h

Seduta h 19 cm.

Chair h 19 cm.

Art. OM 2.110

Vagone giallo / *yellow wagon*

Dim. cm. 110 x 20 x 40 h

Seduta h 16 cm.

Chair h 16 cm.

Art. OM 2.111

Vagone blu / *blue wagon*

Dim. cm. 85 x 20 x 40 h

Seduta h 19 cm.

Chair h 19 cm.

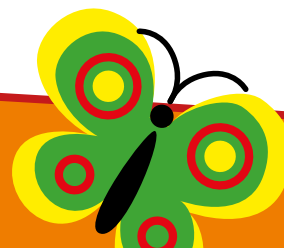
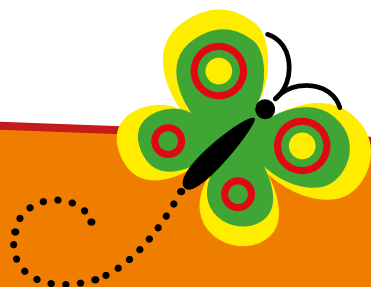



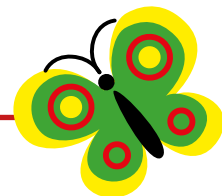

GIOCHI DI MOVIMENTO MOTORY TOYS



ART. OM 2.185

TARTARUGA TUNNEL / TURTLE TUNNEL

Dim. cm 75 x 60 x 50 h

Altezza interna del tunnel 35 cm

Disponibile in due versioni: bicolore o multicolore.

Inner height 35 cm

Available in two versions: bicolor or multicolored.

Tunnel multicolore a forma di simpatica tartaruga, consigliato per bambini fino a 3 anni di età. La testa e le gambe laterali sono ancorabili alla struttura centrale per mezzo di bande di velcro. Il tunnel internamente è dotato di un foglio riflettente assolutamente irrimovibile e sicuro che lo rende più stimolante e divertente.

Multicolored tunnel shaped like a turtle, recommended for children up to 3 years of age. The head and the lateral legs are anchored to the central structure by means of velcro bands. The tunnel internally comes with a non removable and secure reflective sheet that makes it more challenging and fun.



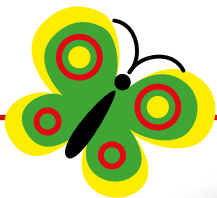

TAPPETO PUZZLE PUZZLE CARPET

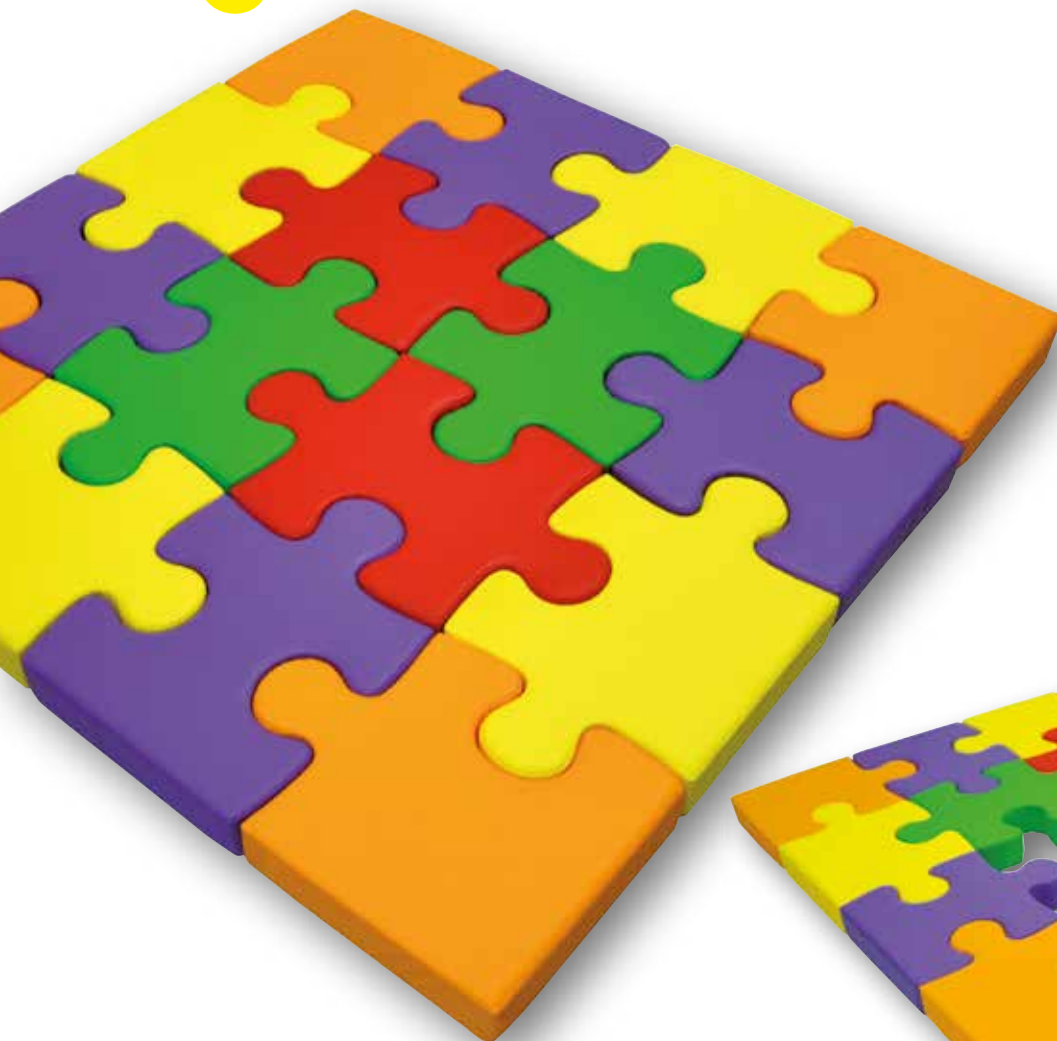

ART. OM 2.144
TAPPETO PUZZLE
PUZZLE CARPET

Composizione di 16 pezzi di spessore 10 cm ancorabili tra loro con sistema di incastro differenziato. Il progetto prevede 12 mattonelle perimetrali fisse e 4 mattonelle centrali versatili; infatti le dimensioni del tappeto possono essere ampliate nel tempo sia in lunghezza che in larghezza aggiungendo mattonelle centrali. Il tappeto puzzle oltre ad essere un grande spazio relax rappresenta anche un valido supporto didattico, in quanto stimola il bambino alla logica, alla manipolazione e alla costruzione.

Composition of 16 pieces 10 cm thick, which can be anchored to each other with a differentiated locking system. The carpet includes 12 fixed perimetral tiles and 4 central versatile tiles. Infact, the dimensions of the carpet can be expanded over time both in length and width by adding central tiles. The puzzle carpet as well as being a great relaxation space is also a valid teaching support, as it stimulates the child to logic, manipulation and construction.

Dimensions / size: cm 160 x 160 x 10 h

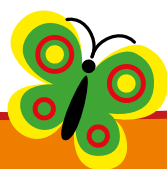





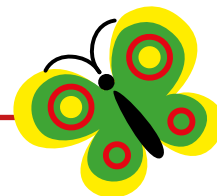

TAPPETO SCACCHI ARLECCHINO E CUBI
COLORFUL CARPET AND CUBE SHAPES



Art. OM 2.388
TAPPETO ARLECCHINO
MULTICOLOR CARPET
Dim. cm 135 x 135 x 4



Art. OM 2.389
CUBO - kit 8 pz.
CUBE - kit 8 pcs.
Cubo lato cm. 20 - Colori assortiti
Cube side cm. 20 - Assorted colors

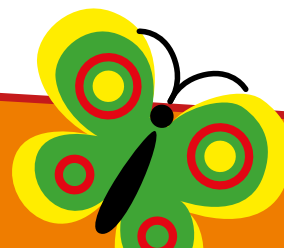
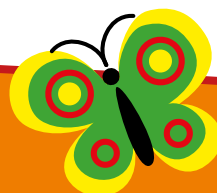

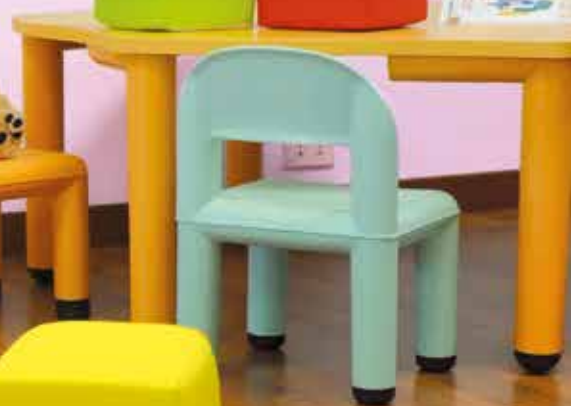

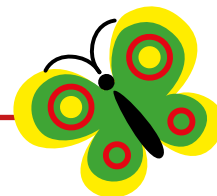

FORME GEOMETRICHE BASE 30 GEOMETRIC SHAPES BASE 30

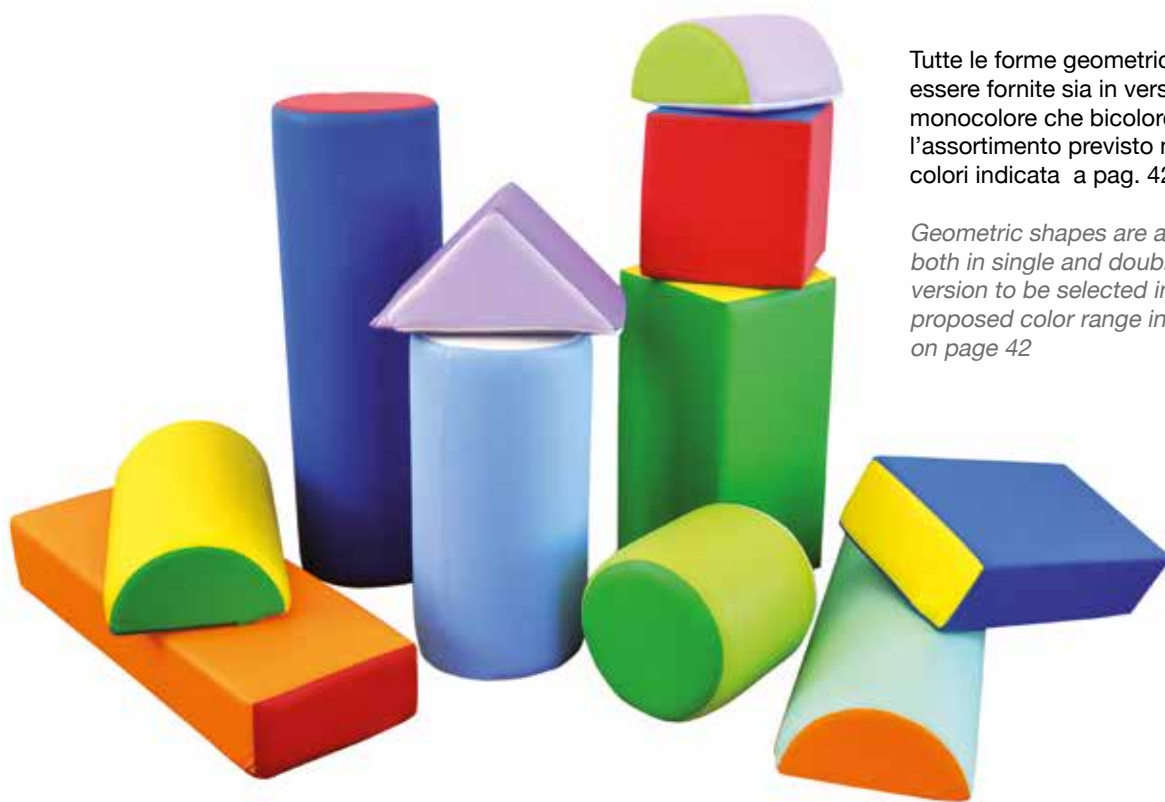

Tutte le forme geometriche possono essere fornite sia in versione monocolore che bicolore con l'assortimento previsto nella gamma colori indicata a pag. 42

Geometric shapes are all available both in single and double color version to be selected in the proposed color range indicated on page 42

Art. OM 2.068

Cubo/ *Cube* 30x30x30 cm
bicolore / *double color*

Art. OM 2.069

Parallelepipedo / *Parallelepiped* 60x30x15 cm
bicolore / *double color*

Art. OM 2.070

Parallelepipedo / *Parallelepiped* 60x30x30 cm
bicolore / *double color*

Art. OM 2.071

Parallelepipedo / *Parallelepiped* 90x30x15 cm
bicolore / *double color*

Art. OM 2.072

Cilindro grande / *Big cylinder* 90x30 cm Ø
bicolore / *double color*

Art. OM 2.073

Cilindro medio / *Medium cylinder* 60x30 cm Ø
bicolore / *double color*

Art. OM 2.074

Cilindro piccolo / *Small cylinder* 30x30 Ø
bicolore / *double color*

Art. OM 2.075

Mezzo cilindro grande / *Half big cylinder* 90x30 sez.
bicolore / *double color*

Art. OM 2.076

Mezzo cilindro medio / *Half medium cylinder* 60x30 sez.
bicolore / *double color*

Art. OM 2.077

Mezzo cilindro piccolo / *Half small cylinder* 30x30 sez.
bicolore / *double color*

Art. OM 2.078

Triangolo / *Triangle* 30 cm lato / *side*
bicolore / *double color*

Art. OM 2.079

Serie 11 forme base 30 / *11 basic shapes set 30*
bicolore assortite / *double color assorted*

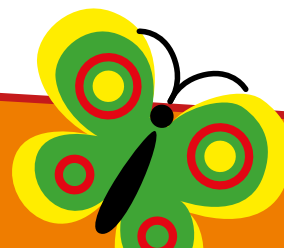
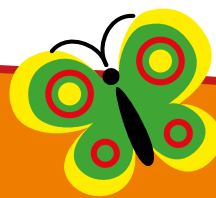
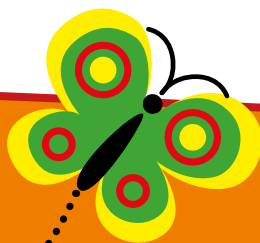

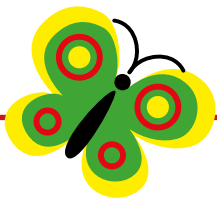

FORME GEOMETRICHE BASE 40 GEOMETRIC SHAPES BASE 40

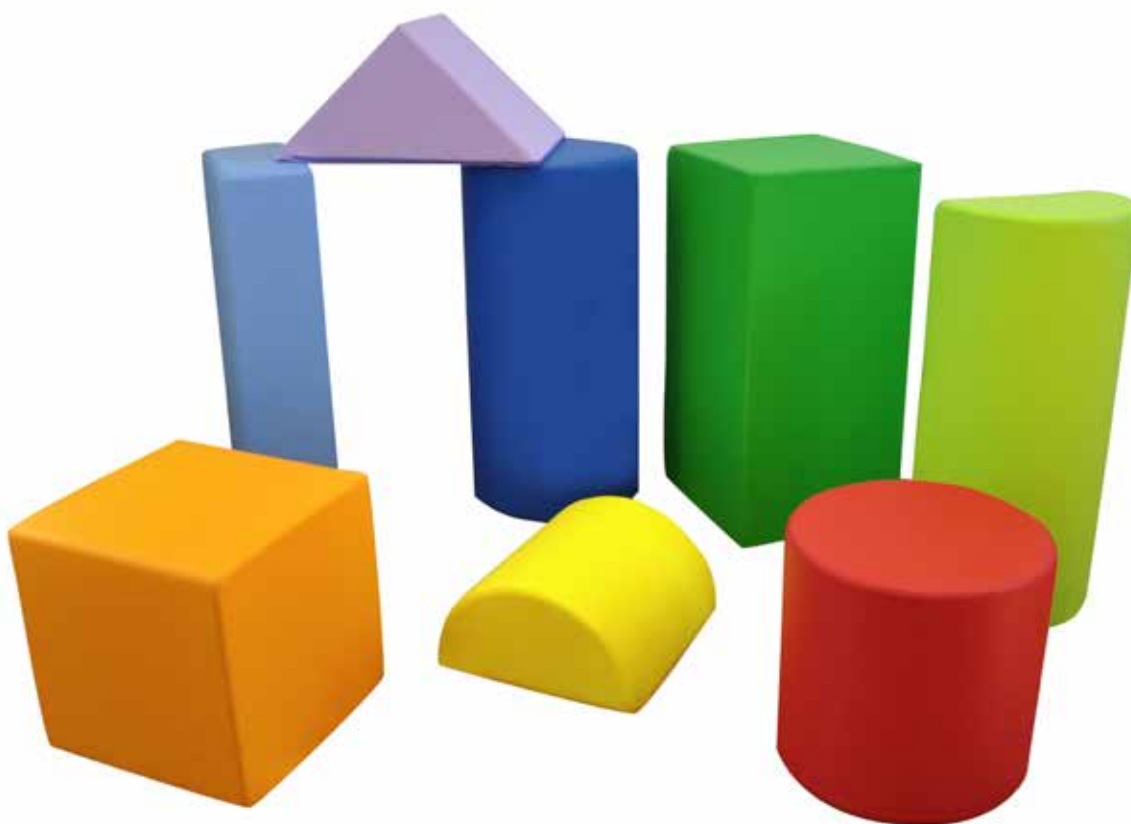

Art. OM 2.080

Cubo / *Cube* 40x40x40 cm
monocolore / *one colour*

Art. OM 2.081

Parallelepipedo / *Parallelepiped* 80x40x20 cm
monocolore / *one colour*

Art. OM 2.082

Parallelepipedo / *Parallelepiped* 80x40x40 cm
monocolore / *one colour*

Art. OM 2.083

Cilindro grande / *Big cylinder* 80x40 cm Ø
monocolore / *one colour*

Art. OM 2.084

Cilindro piccolo / *Small cylinder* 40x40 cm Ø
monocolore / *one colour*

Art. OM 2.085

Mezzo Cilindro grande / *Big half cylinder*
80x40 cm sez.
monocolore / *one colour*

Art. OM 2.086

Mezzo cilindro piccolo / *Small half cylinder*
40x40 cm sez.
monocolore / *one colour*

Art. OM 2.087

Triangolo 40 cm lato / *Triangle 40 cm side*
monocolore / *one colour*

Art. OM 2.088

Serie 8 forme base 40 cm / *Line 8 shapes base 40 cm*
monocolore assortite / *one colour assorted*

Tutte le forme geometriche possono essere fornite sia in versione monocolore che bicolore con l'assortimento previsto nella gamma colori indicata a pag. 42.

Geometric shapes are all available both in single and double color version to be selected in the proposed color range indicated on page 42.

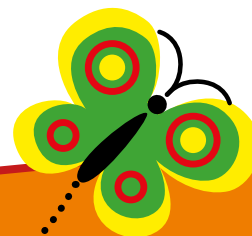
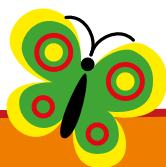

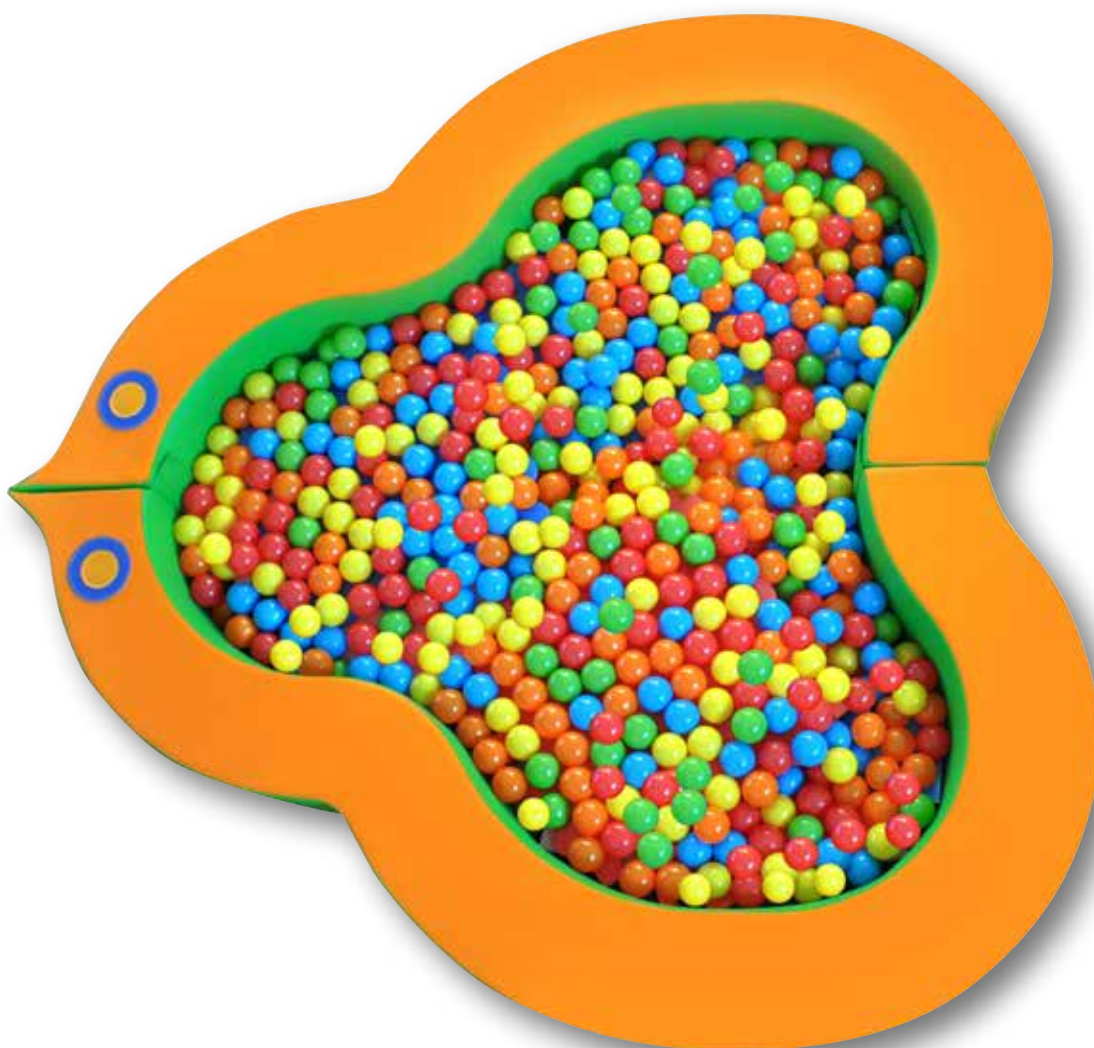
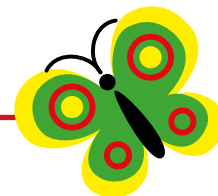

Art. OM 2.063

PISCINA PESCE RAZZA SKATE FISH POOL

Struttura composta da n. 2 elementi sagomati e ancorabili tra loro mediante strisce di velcro.

Fornita con telo di fondo.

structure composed of 2 elements shaped. anchorable one to each other by means of Velcro straps.

Complete with a bottom sheet.

Dim. cm 160 x 140 x 30 h.

Art. OM 2.064

PISCINA PESCE RAZZA CON BOLLE SKATE FISH POOL WITH BUBBLES

Struttura e caratteristiche come l'articolo OM 2.063

Fornita con 1.000 palline Ø 6 cm.

Structure and characteristics as Art. OM 2.063

equipped with 1.000 bubbles Ø 6.

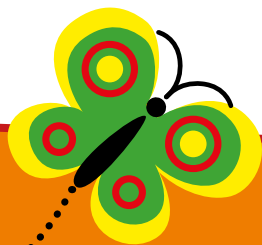



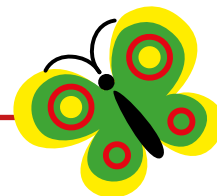

PISCINE / POOLS



Struttura ovale composta da n. 2 elementi ancorabili tra loro mediante fasce di velcro. Completa di telo di fondo.

Dimensioni:

ESTERNE cm. 180 x 180 x 30

INTERNE cm. 140 x 140 x 30

A richiesta può essere fornito con tappeto di fondo Art. OM 2.201

Alla struttura possono essere collegati tutti gli elementi di discesa e/o risalita di pag. 100 con colori Linea materna

Oval structure composed of 2 elements anchorable one to each other by means of Velcro straps. Complete with a bottom sheet.

Dimensions:

EXTERNAL cm. 180 x 180 x 30

INTERNAL cm. 140 x 140 x 30

On request it can be supplied with a bottom carpet. Art. OM 2.201

The structure can be connected to all descent and / or ascent elements of pag. 100 with kindergarten line colors.

Art. OM 2.200

Laghetto colorato

Colored pond

Solo struttura con telo di fondo

Structure with fabric bottom

Art. OM 2.201

Tappeto laghetto colorato

Colored pond carpet

Dim. cm. 140 x 140 x 4

Art. OM 2.202

Laghetto colorato con bolle

Colored pond with bubbles

struttura e caratteristiche come Art. OM 2.200

corredato di 1.000 palline Ø 6

structure and characteristics as Art. OM 2.200

equipped with 1.000 bubbles Ø 6

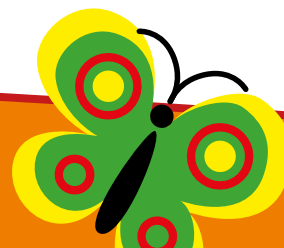
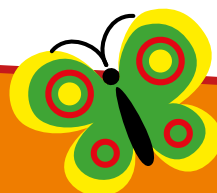
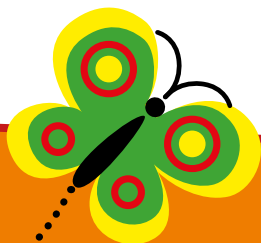

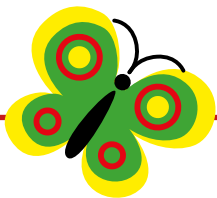

Struttura angolare composta da n. 3 elementi ancorabili tra loro mediante fasce di velcro. A richiesta può essere fornito il materasso di fondo (Art. OM 2.148)

Corner structure composed of n. 3 elements anchorable one to each other by means of Velcro straps.

Upon request it can be supplied with the bottom carpet (Art. OM 2.148)

Il BABY MARE ANGOLARE può essere utilizzato con elementi di discesa o risalita di pag. 100 con colori della Linea materna.

The CORNER BABY SEA SET can be used with descent or ascent elements of pag. 100 with kindergarten line colors.

Dimensioni / Dimensions:

ESTERNE / EXTERNAL cm. 180 x 180 x 30

INTERNE / INTERNAL cm. 150 x 150 x 30

altezza massima pannelli a muro cm. 60
maximum height of wall panels cm. 60

Art. OM 2.147

Baby mare angolare

Corner baby sea

Solo struttura con telo di fondo

Structure with bottom sheet

Dim. cm. 180 x 180 x 30 h.

Art. OM 2.148

Tappeto Baby mare angolare

Corner sea carpet set

Dim. cm. 150 x 150 x 4

Art. OM 2.149

Baby mare angolare con bolle

Corner Baby sea set with bubbles

Struttura e caratteristiche come

Art. OM 2.147

Corredato da 1.000 palline Ø 6

Structure and characteristics as

Art. OM 2.147

Equipped with 1.000 bubbles Ø 6

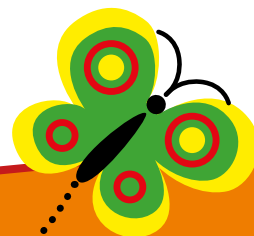

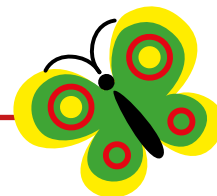

PISCINE / POOLS



Struttura composta da 1 elemento semicerchio h. 30 e 2 pannelli di spessore cm. 6 ancorabili sia tra loro sia al frontale piscina che alla parete con fasce di velcro. A richiesta può essere fornito il tappeto di fondo (Art. OM 2.161)

Dimensioni:

ESTERNE cm 150 x 150 x 30 /100 h

INTERNE cm 120 x 120 x 30 / 100 h

Il LAGHETTO ANGOLARE può essere utilizzato con elementi di discesa e risalita di pag. 100 con colori della linea materna.

Structure composed of 1 element semicircle h. 30 and 2 elements 6 cm. thickness, anchorable one to each other by means of Velcro straps.

On request it can be supplied with a bottom carpet.

(Art. OM 2.161)

Dimensions:

External cm 150 x 150 x 30 /100 h

Internal cm 120 x 120 x 30 / 100 h

It can be equipped with descent or ascent elements indicated on page 100 with color kindergarten line.

Art. OM 2.160

Laghetto angolare

Corner pond

Solo struttura con telo di fondo

Structure with bottom sheet

Dim. cm. 150 x 150 x 30/100 h

Art. OM 2.161

Tappeto Laghetto angolare

Carpet Corner pond

Dim. cm. 120 x 120 x 4

Art. OM 2.162

Laghetto angolare con bolle

Corner pond with bubbles

struttura e caratteristiche come Art. OM 2.160
corredato di 500 palline Ø 6

*structure and characteristics as Art. OM 2.160
equipped with 500 bubbles Ø 6*

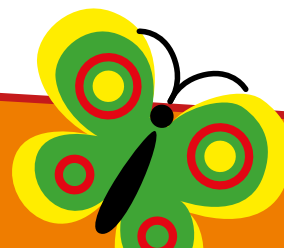
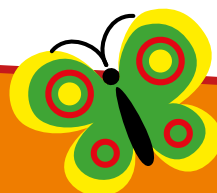
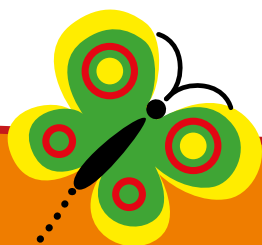



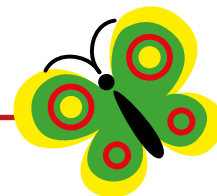

PISCINE / POOLS



Struttura composta da n. 4 pannelli ancorabili tra loro con fasce di velcro. A richiesta può essere fornito il tappeto di fondo (Art. OM 2.171)

Il LAGHETTO QUADRATO può essere utilizzato con elementi di discesa e risalita di pag. 82 (rif.001 - primi percorsi) - In foto esposti articoli 2.002 - elemento scala e 2.003 - elemento scivolo.

Structure composed of 4 elements anchorable one to each other by means of Velcro straps.

Upon request it can be provided with a bottom carpet. (Art. OM 2.171)

It can be equipped with descent or ascent elements indicated on page 82

(rif.001 - nursery paths) - In the pictures are shown art. 2.002 - step element and 2.003 - slide element.

Art. OM 2.170

Laghetto quadrato / Square pond

Solo struttura con telo di fondo. Dimensioni cm.150 x 150 x 45 h.

Only structure with bottom sheet. Dimension cm.150 x 150 x 45 h.

Art. OM 2.171

Tappeto Laghetto quadrato

Square pond Carpet

Dim. cm 120 x 120 x 4

Art. OM 2.172

Laghetto quadrato con bolle

Square pond with bubbles

Struttura e caratteristiche come

Art. 2.170 corredato da 1.000 palline Ø 6

Structure and characteristics as

Art. OM 2.170

Equipped with 1.000 bubbles Ø 6

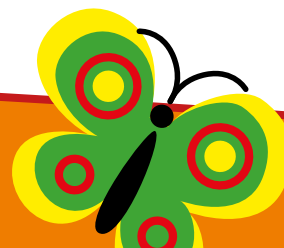
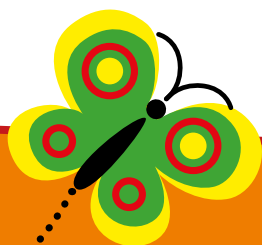
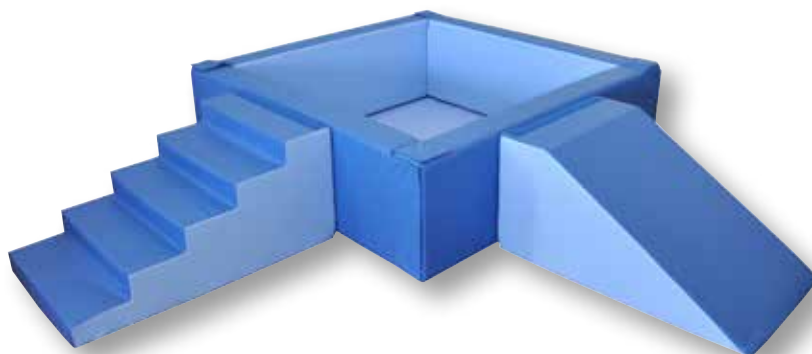

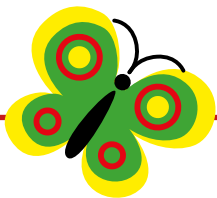

Art. OM 2.154

Laghetto rotondo / Round pond

Struttura composta da 2 elementi semicerchio ancorati tra loro con fasce di velcro. Dotata di telo di fondo. A richiesta può essere fornito il tappeto di fondo (Art. OM 2.155)

Il LAGHETTO ROTONDO può essere utilizzato con elementi di discesa e risalita di pag. 82 (rif. 001 - primi percorsi).

Colori: Su richiesta del cliente l'articolo viene realizzato con colori diversi (vedi gamma 11 colori).

Soft set consisting of 2 semicircular elements anchored together by Velcro straps. Equipped with a bottom sheet. Upon request it can be provided with a carpet box (Art. OM 2.155)

It can be equipped with descent or ascent elements indicated on page 82 (rif. 001 - nursery paths)

Color: On customer request the article is made with different colors (see range 11 colors).

Dim. cm. 180 x 45 h.

Interno / Internal cm. 150 x 45 h.

Art. OM 2155

Tappeto Laghetto rotondo

Carpet round pond

Dim. cm. 150 x 4 (Ø x h)

Art. OM 2.156

Laghetto rotondo con bolle

Round pond with bubbles

Struttura e caratteristiche come Art. OM 2.154

Corredata da n. 1.500 palline di Ø 6

Structure and characteristics as Art. OM 2.154

Equipped with 1.500 bubbles Ø 6

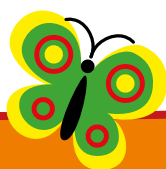

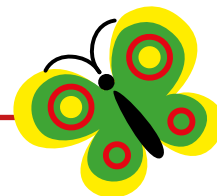

PISCINE / POOLS

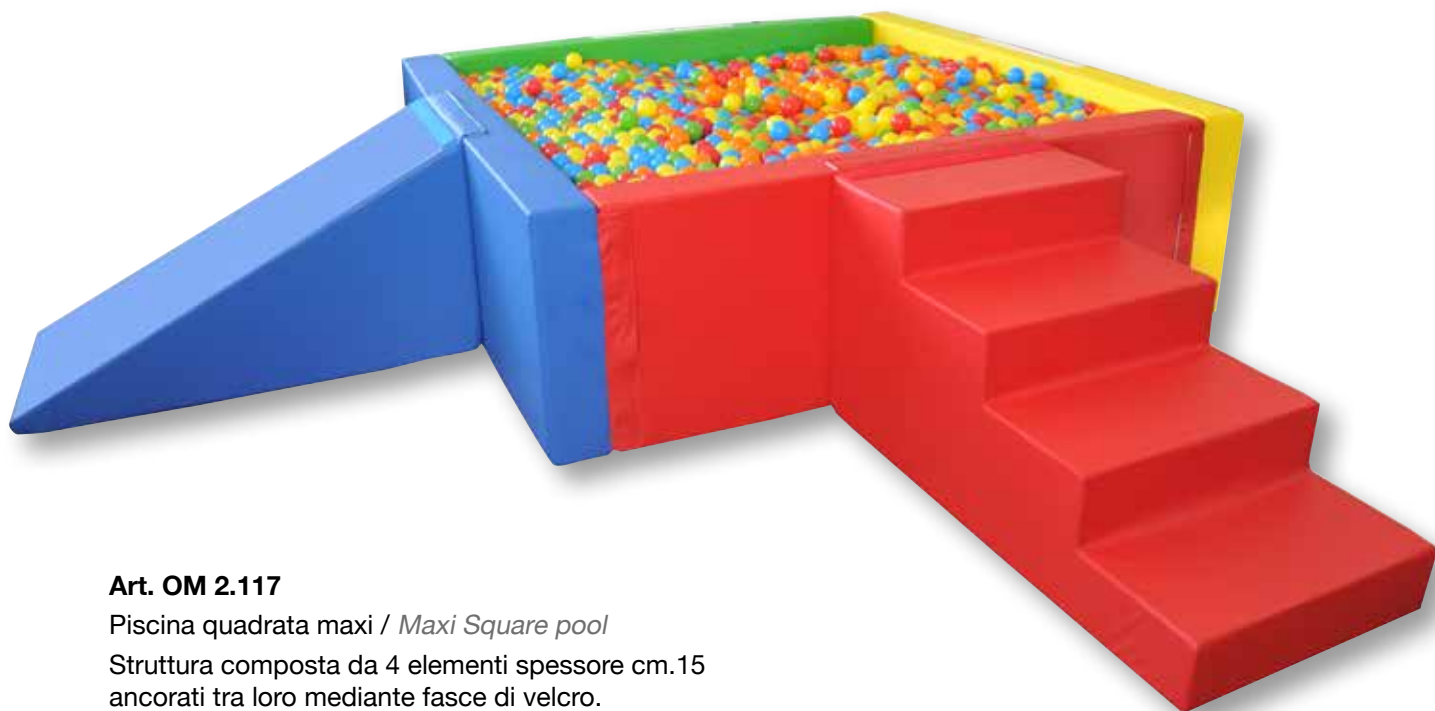

Art. OM 2.117

Piscina quadrata maxi / *Maxi Square pool*

Struttura composta da 4 elementi spessore cm.15 ancorati tra loro mediante fasce di velcro. Dotata di telo di fondo.

A richiesta possono essere forniti elementi di discesa (Art. OM 2.141 - scivolo) e risalita (Art. OM 2.140 - scala) ed il tappeto di fondo (Art. 2.119)

Dimensioni Esterne cm 200 x 200 x 60 h
Dimensioni Interne cm 170 x 170 x 60 h

Structure composed of 4 elements 15 cm. thickness, anchorable one to each other by means of Velcro straps. Equipped with a bottom sheet.

Upon request it can be used with descent elements (Art. OM 2.141 - slide) or ascent elements (Art. OM 2.140 - step) and the bottom carpet (Art. OM 2.119)

*External dimensions cm 200 x 200 x 60 h
Internal dimensions cm 170 x 170 x 60 h*

Art. OM 2.120

Piscina quadrata con bolle
Square pool with bubbles

Struttura e caratteristiche come Art. OM 2.117
Corredata da 2.500 palline Ø 6
*Structure and characteristics as Art. OM 2.117
Equipped with 2.500 bubbles Ø 6*

Art. OM 2.119

Tappeto quadrato / *Square carpet*
Dim. cm 170 x 170 x 4

Art. OM 2.140

Scala maxi / *Maxi step*
Dim. cm 120 x 60 x 60 h

Art. OM 2.141

Scivolo maxi / *Maxi slide*
Dim. cm 120 x 60 x 60 h

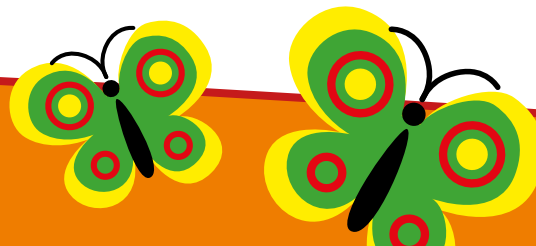



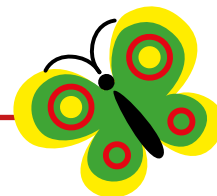

CUSCINI / PILLOWS



ART. OM 2.151

Cuscino quadrato / *Square cushion*

Assortimento in 5 colori vivaci - con maniglia

Kit 5 pezzi

Selection in 5 bright colors with handle

Kit 5 pieces

Dim. cm. 40 x 40 x 5



ART. OM 2.152

Cuscino tondo / *Round cushion*

Assortimento in 5 colori pastello

con maniglia - Kit 5 pezzi

Selection in 5 pastel colors with handle - Kit 5 pieces

Dim. cm. 40 Ø x 5 h.

ART. OM 2.153

Set 10 cuscini

Set 10 cushions

Confezione composta da:

5 cuscini quadrati

e 5 cuscini tondi.

Pack consists of:

5 square cushions

and 5 round cushions



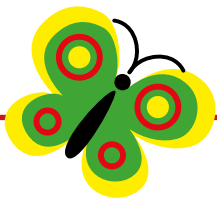

ART. OM 2.145

Cuscini arlecchino
Multicolor cushions

Kit 8 pezzi - Interno in poliester
Assortimento in 8 vivaci colori
*Kit 8 pieces - Polyester internal
Selection of 8 bright colors*

Dim. cm. 42 x 42



ART. OM 2.159

Seduta a fiore - Conf. 6 Pz. / *Flower sitting set - Set 6 Pcs.*

Struttura composta da seduta circolare centrale
diametro 60 x 25 h e da 5 sedute laterali
dim. 45 x 25 h ancorabili tra loro con fasce di velcro.
Dimensione totale cm. 120 x 120 x 25 h.

*Structure composed of central circular seat
diameter 60 x 25 h and 5 lateral poufs dim. 45 x 25 h
dockable one to the other by means of straps
anchorable velcro.*

Total size cm. 120 x 120 x 25 h.

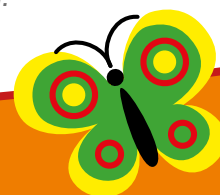
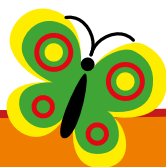

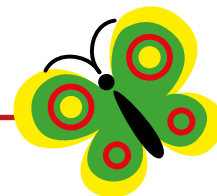

PERCORSI / PATHS



Art. OM 2.150

Arrampicata a petali - Conf. 6 PZ.

Climbing set with petals - Kit. 6 PCS.

Composizione di 1 elemento cerchio centrale diametro 60 cm x 8 h e di 5 elementi petalo dim. cm 45 x 37 ad altezze differenziate (1 da 8 cm - 2 da 16 cm - 2 da 25 cm). Tutti gli elementi sono ancorabili tra loro con fasce di velcro.

Composition of 1 piece center circle diameter 60 cm x 8 h and 5

Petals dim. cm 45 x 37 of different heights (1 of 8 cm - 2 of 16 cm - 2 of 25 cm).

All elements can be connected one to the other by means of strips of velcro.



Art. OM 2.146

Sacco bimbo

Baby sack

Interno con poliestere

Dim. cm.100 x 50 (h x diametro)

Colori: a richiesta possono essere forniti monocolori o arlecchino (vedi gamma 11 colori)

Polyester interior

Diam. 100 cm x 50 (h x diameter)

Colours: upon request can be supplied single color or harlequin (see range 11 colors)

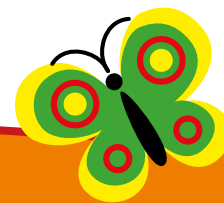
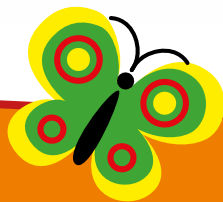

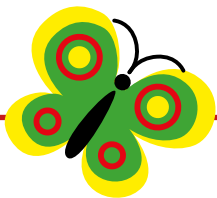

Art. OM 2.157

Divano ad angolo / *Corner sofa*

Composizione di materasso di fondo dimensione cm 150 x 150 x 15, tagliato in diagonale, e 2 schienali sagomati. Dimensioni cm.150 x 25 - Tutti gli elementi sono ancorati con velcro.

Dimensione divano aperto: cm.150 x150 x 15 h

Dimensione divano chiuso: cm.150 x150 x 30 h - base cm. 220

Composition of dim. cm.150 x 150 x 15 bottom mattress, cut diagonally, and 2 contoured backrests.

Size 150 cm x 25 - All the elements are anchored with Velcro.

Sofa open size: 15 x 150 cm x 15 h

Sofa closed size: 150 cm x150 x 30 h - base cm. 220



TUNNEL



Art. OM 2.015

Tunnel cilindrico

Tunnel cylinder

Dimensioni tunnel cm. 100 x 55 Ø

Dimensioni cilindro cm. 100 x 35 Ø

Size tunnel cm. 100 x 55 Ø

Dimensions cylinder cm. 100 x 35 Ø

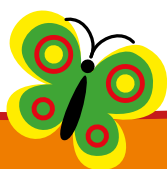

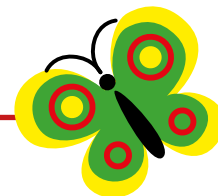

TUNNEL

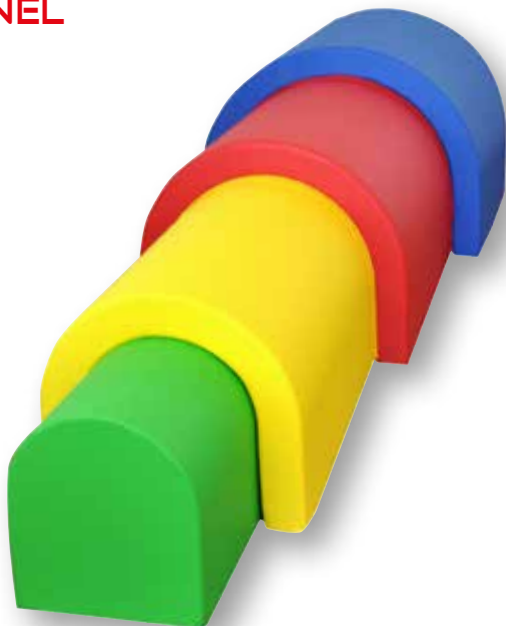

Tunnel piccolo / *Small Tunnel*: dim. cm. 100 x 60 x 55 h
Tunnel medio / *Medium Tunnel*: dim. cm. 100 x 80 x 65 h
Tunnel grande / *Large Tunnel*: dim. cm. 100 x 100 x 75 h

Composizione di tunnel decrescenti. I singoli elementi, sovrapponibili, consentono di sviluppare una struttura lunga fino a 3 mt. (elemento pieno sempre compreso nella struttura)

Composition of decreasing tunnels. The individual elements, overlapping, enable the development of a structure up to 3 meters long. (solid element always included in the structure)



Art. OM 2.114

Galleria 3 / *Gallery 3*

Kit 4 pz. (comprensivo di elemento pieno)
(1 x piccolo - medio - grande)
Set 4 pcs. (included solid element)
(1 x small - medium - large)

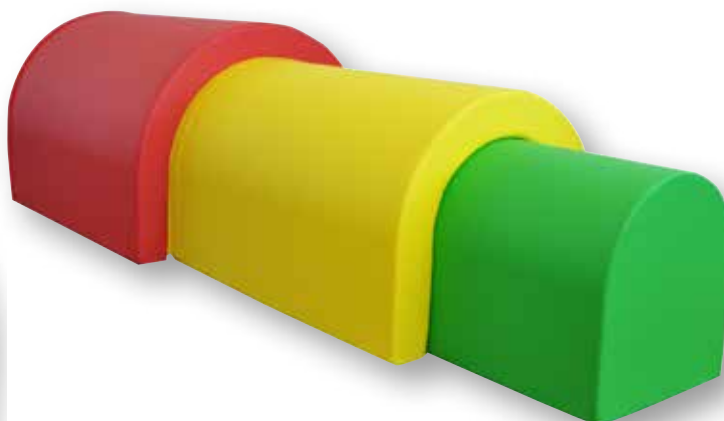

Art. OM 2.115

Galleria 2 / *Gallery 2*

Kit 3 pz. (comprensivo di elemento pieno)
(1 x piccolo - medio)
Set 3 pcs. (included solid element)
(1 x small - medium)

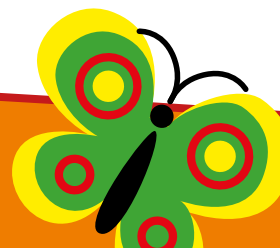
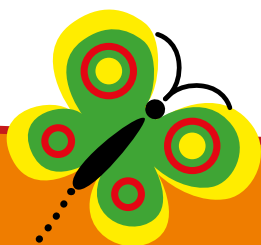

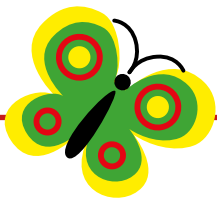

Struttura completa composta da / Complete soft set composed of:

2 elementi scala / 2 step element,
2 elementi scivolo / 2 slide element,
2 elementi onda / 2 wave element,
2 elementi tunnel / 2 tunnel element

Tutti gli elementi sono accostabili ed ancorabili mediante strisce di velcro che ne consentono modularità e stabilità.
All the elements can be joined and anchored together by means of Velcro straps enabling modularity and stability.

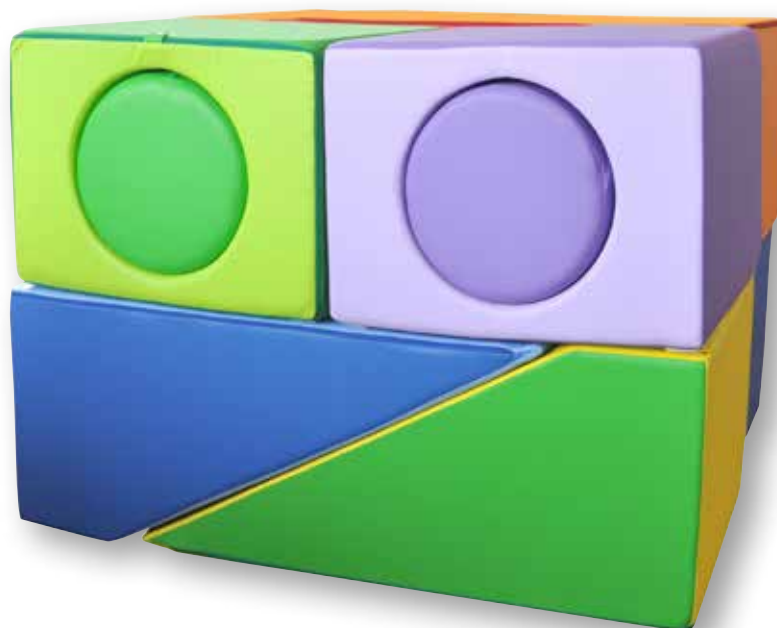

Art. OM 2.001

Kit psicomotorio completo - 8 pz.
Psychomotor kit complete - 8 pcs.

Dimensioni: struttura riposta
Size: folded structure
cm. 120 x 120 x 90

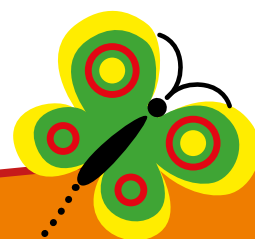
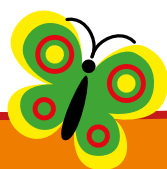

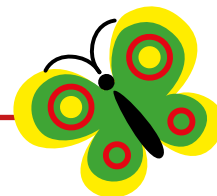

PERCORSI PATHS

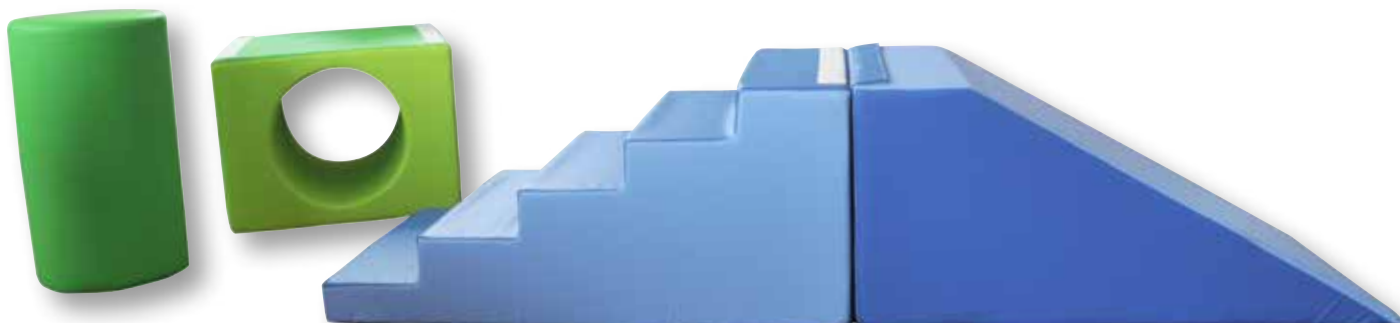

Art. OM 2.001

Kit psicomotorio completo - 8 pz.
Psychomotor kit complete - 8 pcs.

Dimensioni: struttura riposta
Size: folded structure

cm. 120 x 120 x 90



Art. OM 2.002

Elemento scala / *Step element*
Dim. cm. 100 x 60 x 45 h

Art. OM 2.003

Elemento scivolo / *Slide element*
Dim. cm. 100 x 60 x 45 h

Art. OM 2.004

Elemento Onda / *Wave element*
Dim. cm. 100 x 60 x 45 h

Art. OM 2.005

Elemento tunnel / *Tunnel element*
Dim. cm. 60 x 60 x 45 h
Tunnel Ø cm. 35 h

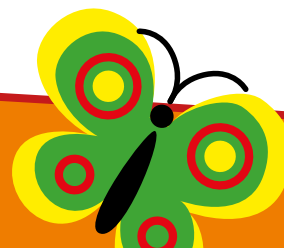
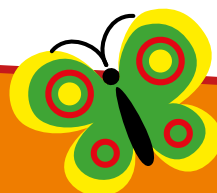
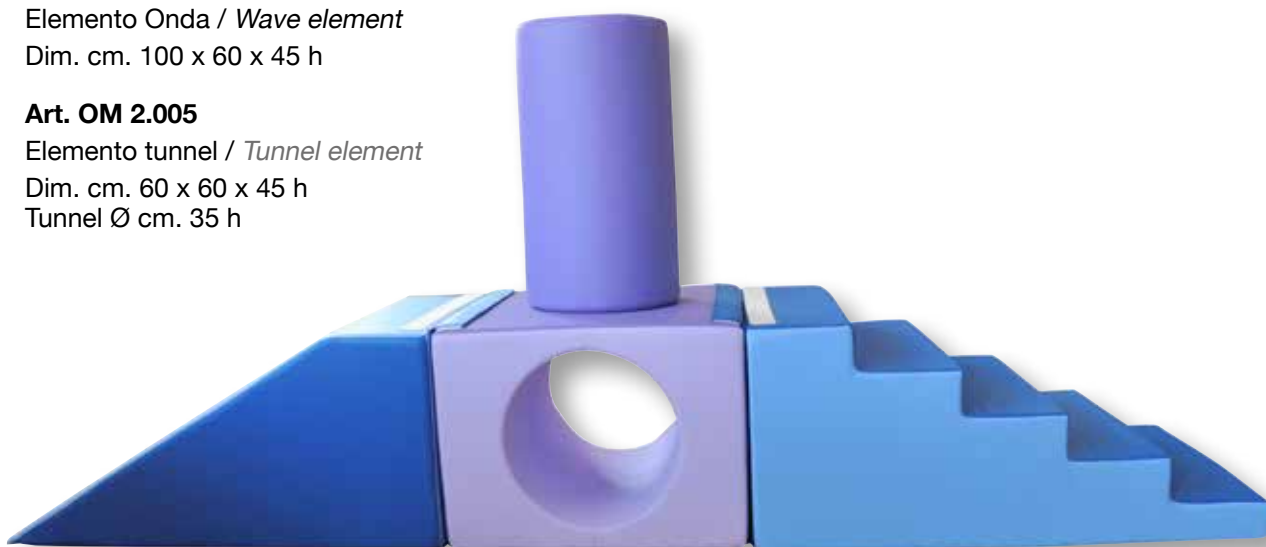

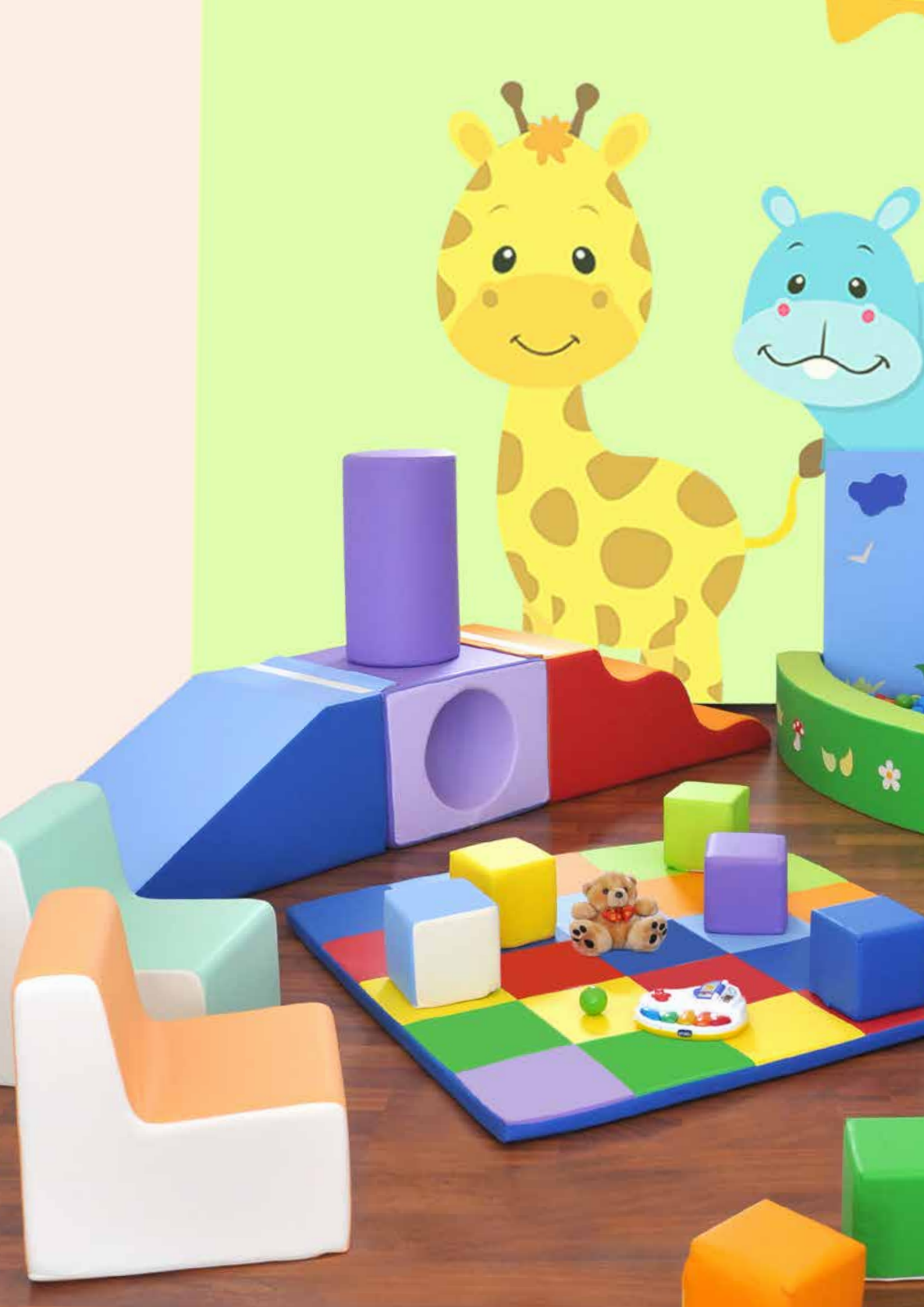

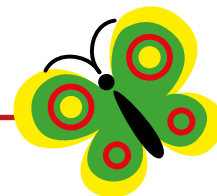

MODULI / MODULE

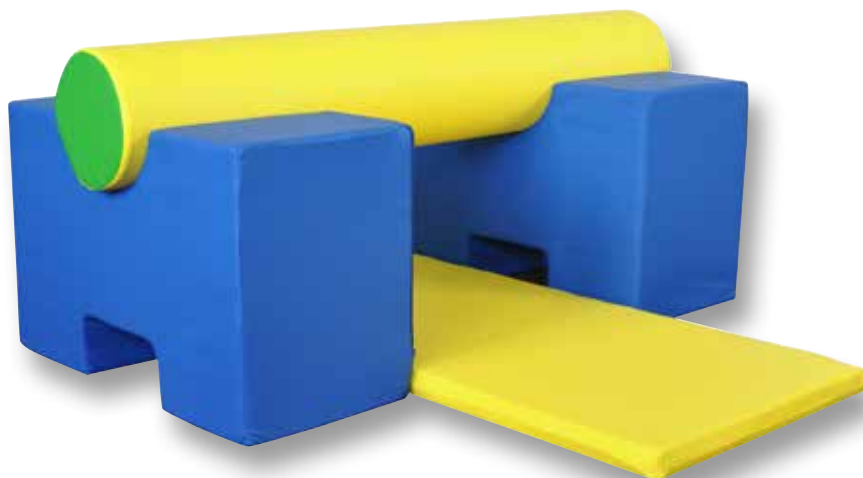

Art. OM 2.179

MINI MODULO 1

MINI MODULE 1

Composto da:

Elemento cilindrico 1 pz.

Elemento base multiuso 2 pz.

Elemento materasso 1 pz.

Composed of:

Cylindrical element 1 pc.

Multipurpose base element 2 pcs.

Mattress element 1 pc.

Art. OM 2.180

MINI MODULO 2

MINI MODULE 2

Composto da:

Elemento trave 1 pz.

Elemento base multiuso 2 pz.

Elemento materasso 1 pz.

Composed of:

Beam element 1 pc.

Multipurpose base element 2 pcs.

Mattress element 1 pc.



SINGOLI COMPONENTI SINGLE COMPONENTS

Art. OM 2.173

Elemento cilindrico

Cylindrical element

Dim. cm. 120 x 20 Ø

Art. OM 2.175

Elemento base multiuso

Multipurpose base element

Dim. cm 60 x 30 x 40 h

Art. OM 2.174

Elemento trave

Beam element

Dim. cm. 120 x 20 x 20 h

Art. OM 2.176

Elemento materasso

Mattress element

Dim. cm. 150 x 50 x 4

Elemento base multiuso permette di utilizzare tutti i singoli elementi (travi, cilindri, cerchi e semicerchi) nella massima sicurezza e stabilità

Multipurpose base element that allows the use all of the individual elements (beams, cylinders, circles and semicircles) with maximum safety and stability

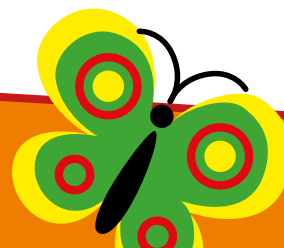
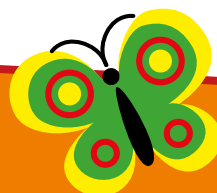
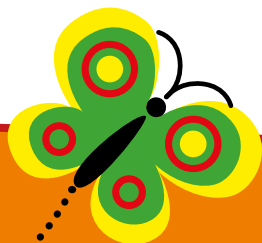

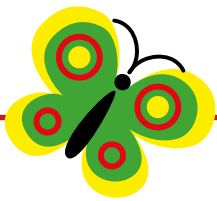

Art. OM 2.181
MINI MODULO 3
MINI MODULE 3

Composto da:
Elemento semicerchio 1 pz.
Elemento base multiuso 2 pz.
Elemento materasso 1 pz.

Composed of:
Semicircle element 1 pc.
Multipurpose base element 2 pcs.
Mattress element 1 pc.

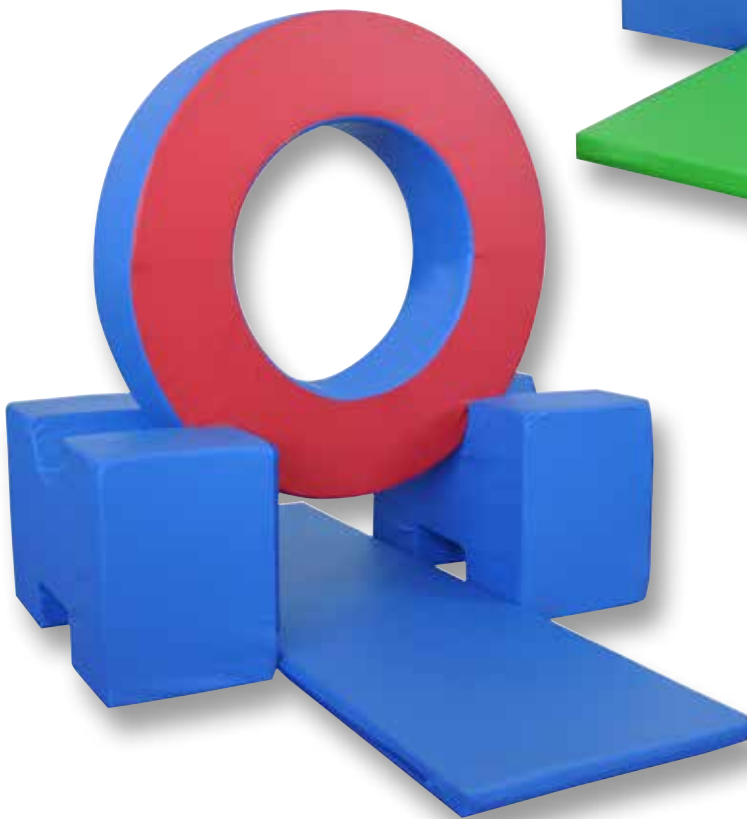

Art. OM 2.182
MINI MODULO 4
MINI MODULE 4

Composto da:
Elemento cerchio 1 pz.
Elemento base multiuso 2 pz.
Elemento materasso 1 pz.

Composed of:
Circle element 1 pc.
Multipurpose base element 2 pcs.
Mattress element 1 pc.

SINGOLI COMPONENTI SINGLE COMPONENTS

Art. OM 2.175
Elemento base multiuso
Multipurpose base element
Dim. cm. 60 x 30 x 40 h

Art. OM 2.176
Elemento materasso
Mattress element
Dim. cm. 150 x 50 x 4

Art. OM 2.177
Elemento semicerchio
Semicircle element
Dim. cm. 90 x 20 (Ø x h)
Sezione cm. 45 / *Section cm. 45*

Art. OM 2.178
Elemento cerchio
Circle element
Dim. cm. 90 x 20 (Ø x h)

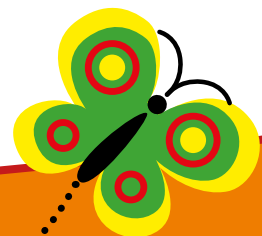
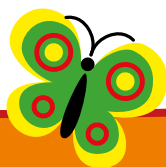

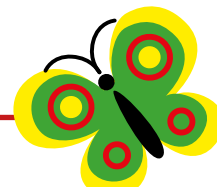

ANGOLO MORBIDO SOFT CORNER

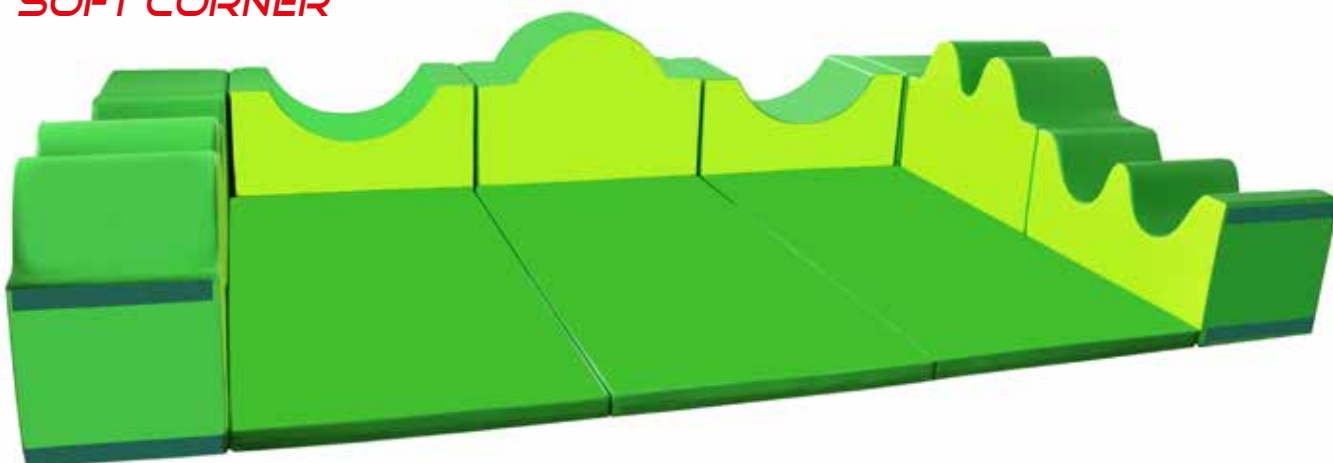

Grande angolo morbido particolarmente indicato per attività motorie, ludiche e di socializzazione.

Tutti i componenti proposti (onda 1/2/3/4) sono modulari, ancorabili tra loro con fasce di velcro e consentono di modificare e/o ampliare il vs. angolo in base agli spazi disponibili ed al numero di bambini presenti.

Le altezze e le larghezze impiegate permettono di camminare e gattonare sui moduli con estrema sicurezza.

In queste pagine proponiamo un esempio di composizione realizzata con rivestimenti dai colori verdi (chiaro/scuro) ma, su richiesta, possono essere ordinati con altre combinazioni di colore da selezionare nella gamma esposta a pag. 42 (es. blu/azzurro)

Large soft corner particularly suitable for physical activities, games and socialization.

All the proposed modules (1/2/3/4 wave) are modular, anchorable one to each other with Velcro straps and allow you to modify and / or expand your corner size according to the available spaces and the number of children

Heights and widths used allow you to walk and crawl on the modules with extreme safety.

In these pages we offer an example of a composition formed with modules of different shades of green (Light / dark), but, on request, can be ordered with different color combinations to be selected in the range of colors proposed on page. 42 (ex. Blue / Light Blue)

Art. OM 2.142

Angolo morbido Maxi / Maxi Soft corner

Kit 12 pezzi / Kit 12 pieces

Composizione di 7 onde assortite

2 angolari - 3 tappeti 180 x 90 x 6 cm

Dimensione totale montato cm. 360 x 225 x 45 h

Composition of 7 assorted waves

2 corner - 3 carpet 180 x 90 x 6 cm

Total dimension cm. 360 x 225 x 45 h

Art. OM 2.143

Angolo morbido Midi / Midi Soft corner

Kit 10 pezzi / Kit 10 pieces

Composizione di 6 onde assortite

2 angolari - 2 tappeti 180 x 90 x 6 cm

Dimensione totale montato cm. 270 x 225 x 45 h

Composition of 6 assorted waves

2 corner - 2 carpet 180 x 90 x 6 cm

Total dimension cm. 270 x 225 x 45 h

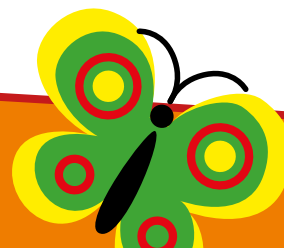
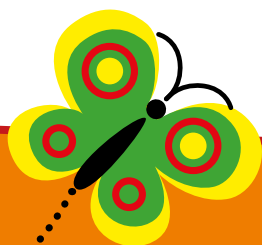

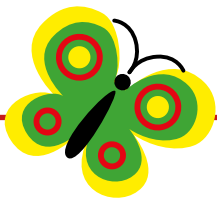

ANGOLO MORBIDO SOFT CORNER

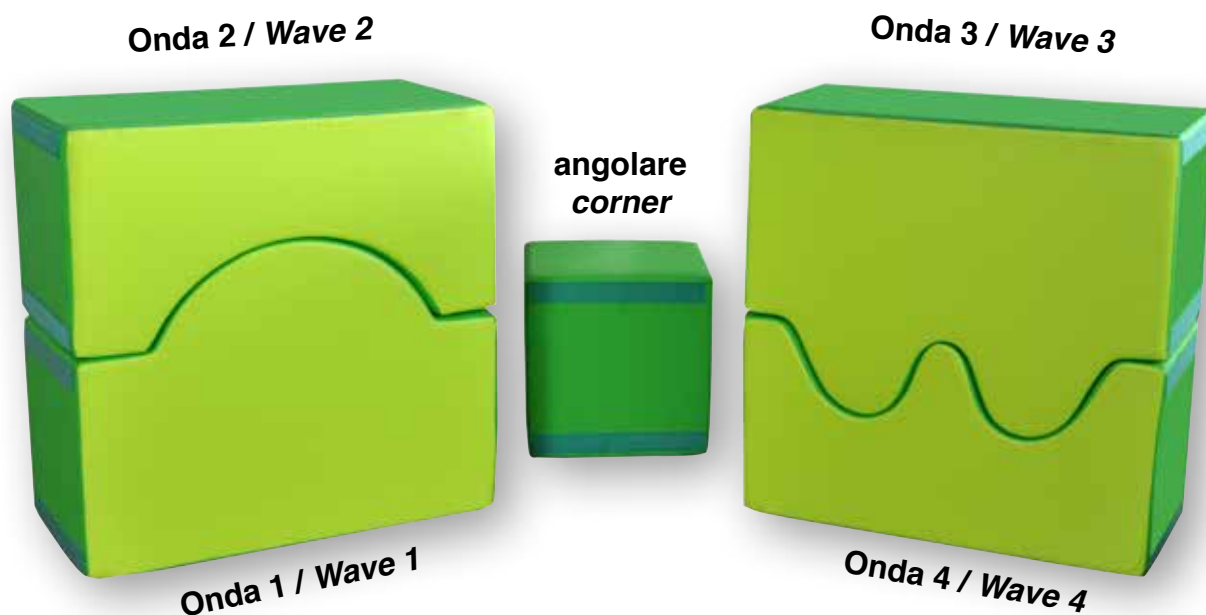

Art. OM 2.163

Onda 1 - Wave 1

1 Ondina convessa

1 small convex wave

Dim. cm. 90 x 45 x 45 / 65 h

Art. OM 2.164

Onda 2 - Wave 2

1 Ondina concava

1 small concave wave

Dim. cm. 90 x 45 x 45 / 25 h

Art. OM 2.165

Onda 3 - Wave 3

1 Ondina convessa

1 small convex wave

Dim. cm. 90 x 45 x 45 / 65 h

Art. OM 2.166

Onda 4 - Wave 4

1 Ondina concava

1 small concave wave

Dim. cm. 90 x 45 x 45 / 25 h

Art. OM 2.167

Angolare - Corner

Dim. cm. 45 x 45 x 45 h

Art. OM 2.168

Tappeto grande - Maxi carpet

Dim. cm. 180 x 90 x 6

Art. OM 2.169

Tappeto midi - Medium carpet

Dim. cm. 90 x 90 x 6

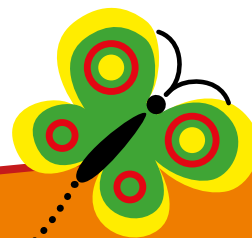
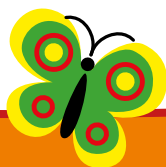
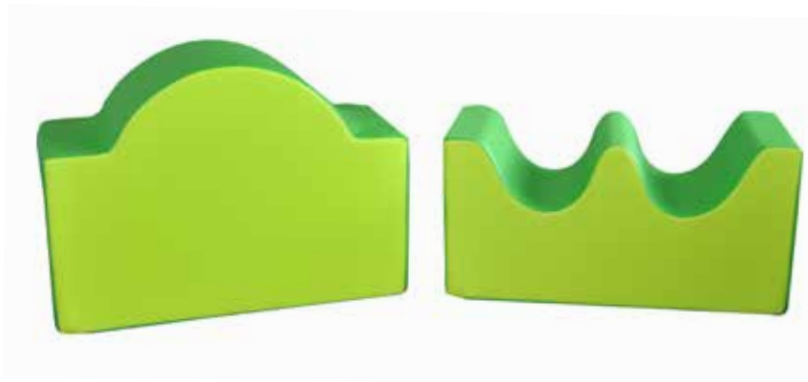

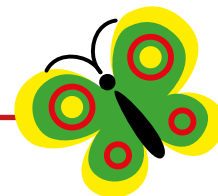

MATERASSI / MATTRESS

Con rivestimento in tessuto plastico monosplamato / Covered with Spread plastic fabric



Materassino cm. 120X60x4
Little Mattress cm. 120X60x4

Art. OM 2.101
Monocolore / One colour

Art. OM 2.102
Set 4 Materassini cm. 120 X 60 x 4
Set 4 mattresses cm. 120 X 60 x 4



Materassino cm. 140 x 70 x 4
Little Mattress cm. 140 x 70 x 4

Art. OM 2.097 - Monocolore / One colour
Art. OM 2.1097 - Bicolore / Double color

Materassino cm. 140 x 140 x 4
Little Mattress cm. 140 x 140 x 4

Art. OM 2.098 - Monocolore / One colour
Art. OM 2.1098 - Bicolore / Double color

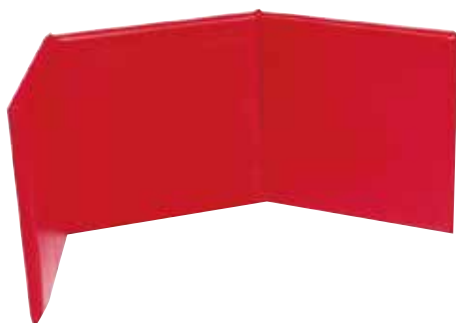

Art. OM 2.100
Materassino Pieghevole
Folding Mattress
cm. 180 X 60 x 4
Monocolore / One colour



MONOCOLORE ONE COLOUR	R	B	V	G
BICOLORE DOUBLE COLOR	R/B	G/V	B/G	V/B

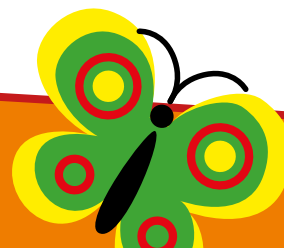

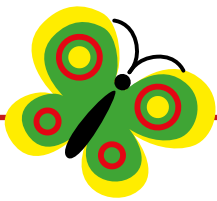

MATERASSI / MATTRESS

Con rivestimento in tessuto plastico monosplamato / Covered with Spread plastic fabric



Materassino / Little mattress

180 x 70 x 4 cm

Art. OM 2.089 - Monocolore / One colour

Art. OM 2.1089 - Bicolore / Double color

Materassino / Little mattress

180 x 70 x 6 cm

Art. OM 2.090 - Monocolore / One colour

Art. OM 2.1090 - Bicolore / Double color

Materasso / Mattress

200 x 100 x 6 cm

Art. OM 2.091

Monocolore / One colour

Art. OM 2.1091

Bicolore / Double color



Materasso / Mattress

200 x 100 x 10 cm

Art. OM 2.092

Monocolore / One colour

Art. OM 2.1092

Bicolore / Double color



Materasso / Mattress

200 x 100 x 20

Art. OM 2.093

Monocolore / One colour



Materassone / Big mattress

200 X 200 x 6 cm

Art. OM 2.096

Monocolore / One colour

Art. OM 2.1096

Bicolore / Double color

Materasso gigante / Giant mattress

300 x 200 x 6 cm

Art. OM 2.106

Monocolore / One colour

Art. OM 2.1106

Bicolore / Double color

MONOCOLORE ONE COLOUR	R	B	V	G
BICOLORE DOUBLE COLOR	R/B	G/V	B/G	V/B

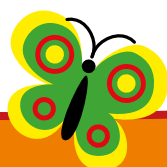

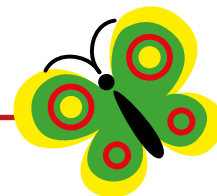

TAPPETO PIEGHEVOLE MAXI MAXI FOLDING CARPET



ART. OM 2.158

TAPPETO PIEGHEVOLE MAXI
FOLDING MAXI CARPET

Rivestito con tessuto Happy, particolarmente robusto ed ignifugo in classe 1IM, consente di essere piegato e facilmente riposto. In 4 colori vivaci. Dimensione cm. 240 x 180 x 3

Covered with HAPPY fabric, strong and Fire ret. Cl. 1IM, is easily foldable and stored away.

Available in 4 bright colors. Size 240 x 180 x 3 cm.

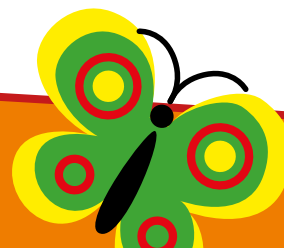
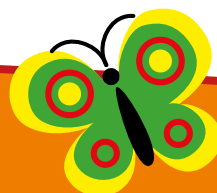

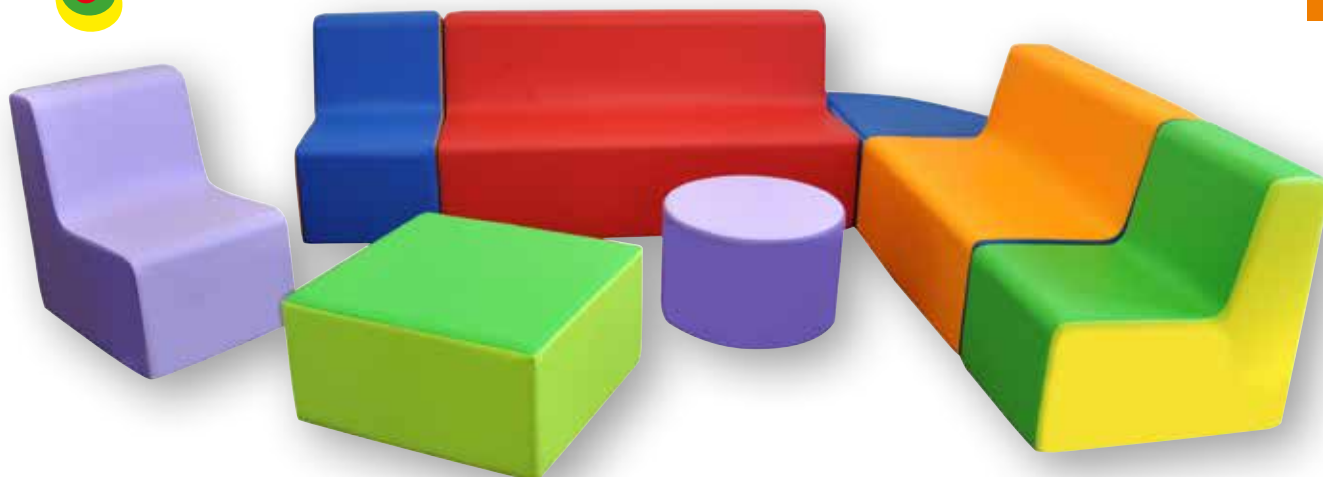
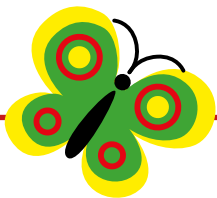

NUOVO ANGOLO SEDUTE BAMBINI NEW CHILDREN CHAIRS CORNER

Art. OM 4.124

DIVANETTO 2 posti / SOFA 2 people
Dim. cm 70 x 48 x 50 h
Altezza seduta cm. 25 h
Seat height cm. 25 h
Bicolore / Double color

Art. OM 4.125

POLTRONCINA / LITTLE ARMCHAIR
Dim. cm 35 x 48 x 50 h
Altezza seduta cm. 25 h
Seat height cm. 25 h
Bicolore / Double color

Art. OM 4.126

DIVANETTO 3 posti / SOFA 3 people
Dim. cm 100 x 48 x 50 h
Altezza seduta cm. 25 h
Seat height cm. 25 h
Bicolore / Double color

Art. OM 4.127

DIVANETTO 6 posti / SOFA 6 people
Dim. cm 200 x 48 x 50 h
Altezza seduta cm. 25 h
Seat height cm. 25 h
Bicolore / Double color

Art. OM 4.128

POUF ANGOLARE / CORNER POUF
Dim. cm. 48 x 48 x 25 h
Bicolore / Double color

Art. OM 4.129

POUF QUADRATO / SQUARE POUF
Dim. cm. 48 x 48 x 25 h
Bicolore / Double color

Art. OM 4.130

POUF CIRCOLARE / ROUND POUF
Dim. cm. 38 X 25 (Ø x h)
Bicolore / Double color

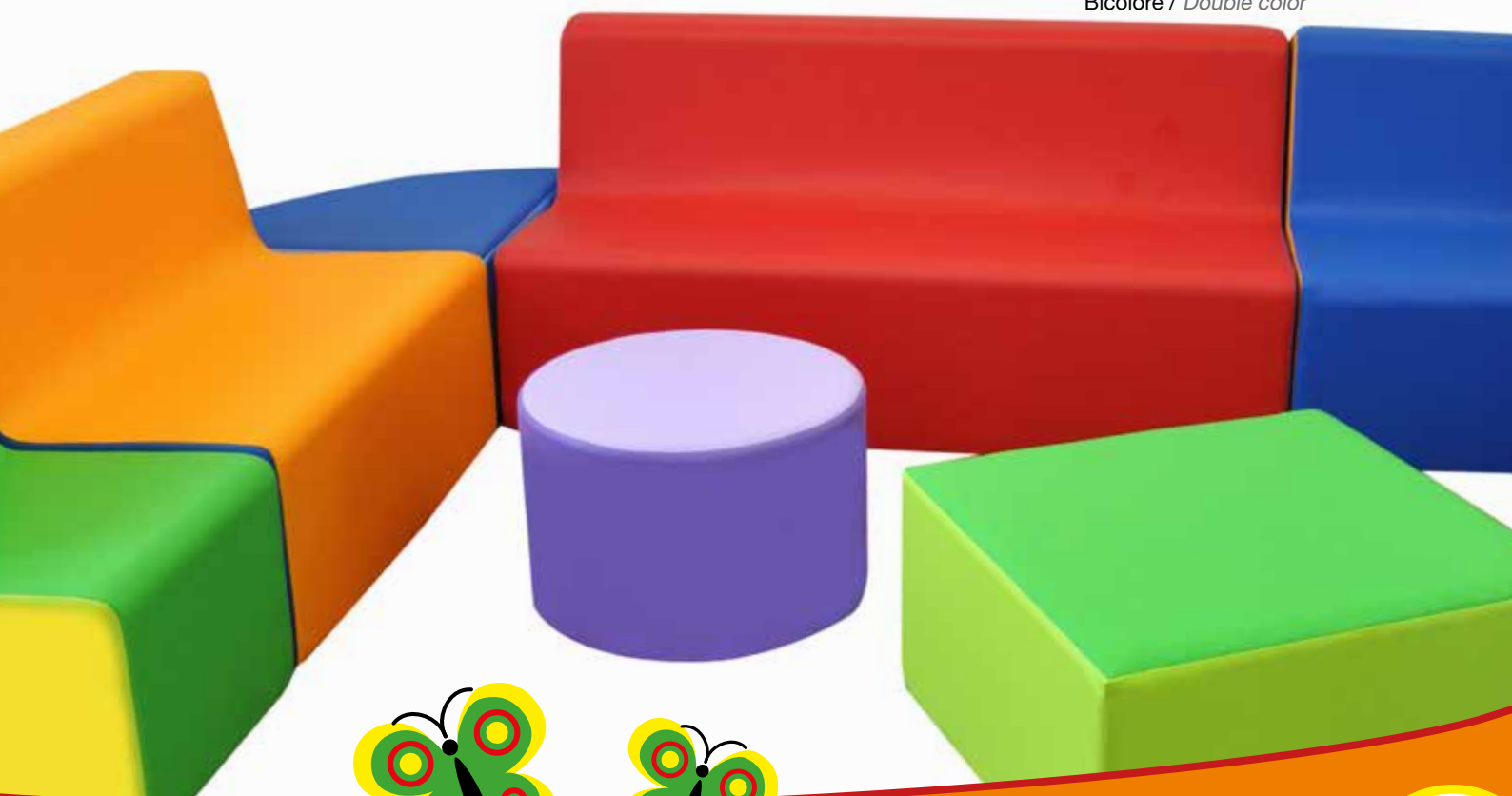

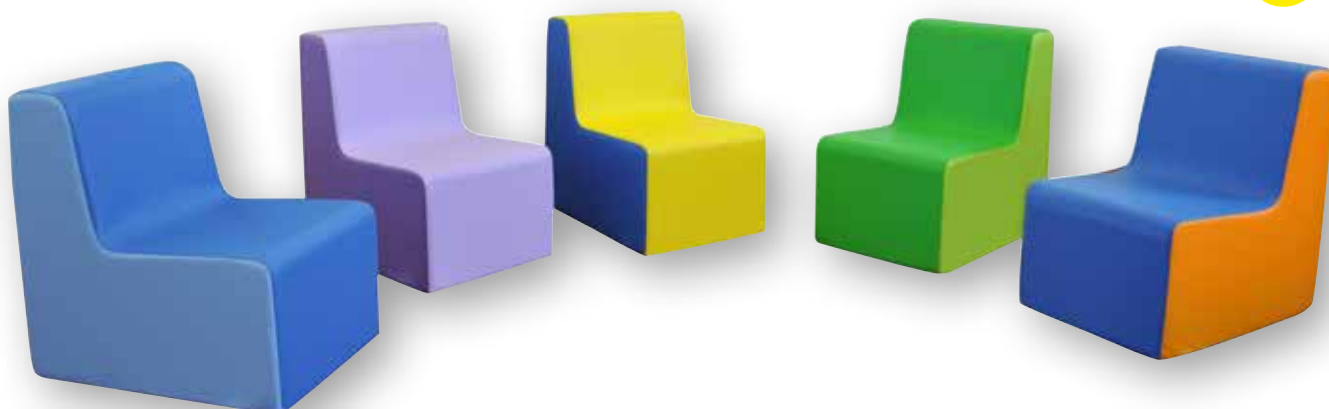
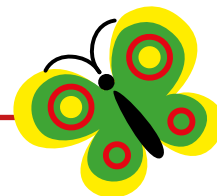

Colori: tutte le sedute per la Linea Materna vengono proposte bicolore ma possono essere fornite anche in versione monocolore con l'assortimento indicato a pag. 42. In sede di ordine si prega di indicare i colori desiderati (N.B. per la scelta bicolore il primo colore indica le patelle laterali mentre il secondo indica il colore delle sedute).

Colors: all seats of the Kindergarten Collection are proposed in two colors, but can be also supplied in single-color version to be selected from the range indicated at page 42. Upon placing the order please indicate the required colors (Please note: for the two colors choice, the first color is the one of the side flaps while the second one is the one relevant to the seats).

SEDUTE ADULTI / ADULTS CHAIRS



Art. OM 4.131

POLTRONA ADULTI
ARMCHAIR FOR ADULTS

Dim. cm. 55 x 70 x 75 h
Altezza seduta h 40
Seat height h 35
Bicolore / Double color

Art. OM 4.132

DIVANO ADULTI
SOFA FOR ADULTS

Dim. cm. 110 x 70 x 75 h
Altezza seduta h 40
Seat height h 40
Bicolore / Double color

Art. OM 4.133

POUF ADULTI
POUF FOR ADULTS

Dim. cm. 48 x 48 x 40 h
Bicolore / Double color



Art. OM 4.131

Art. OM 4.125

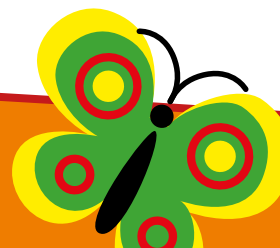
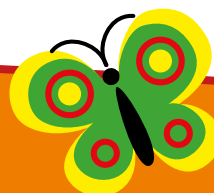
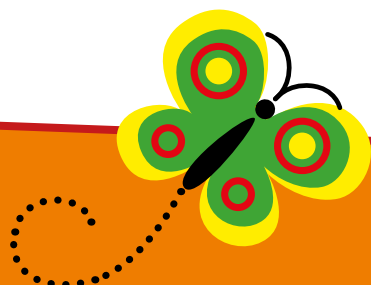

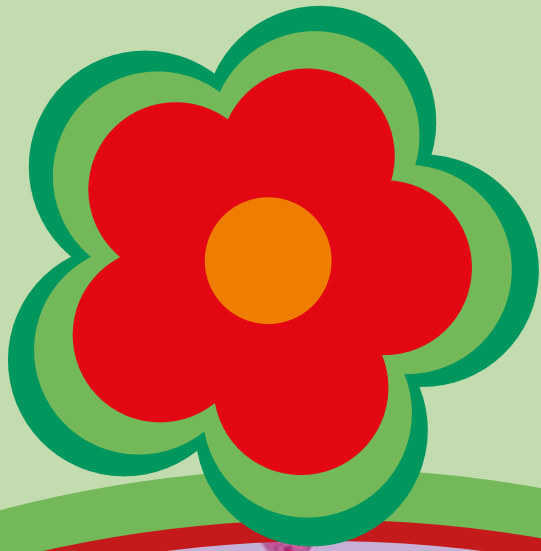

Linea nido NURSERY Line





PERCORSI / PATHS



POUF / PILLOWS

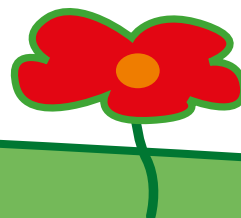



**ANGOLO MORBIDO
SOFT CORNER**

PISCINE / POOLS

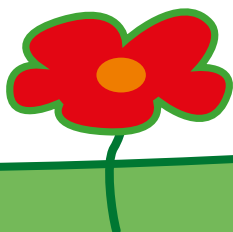
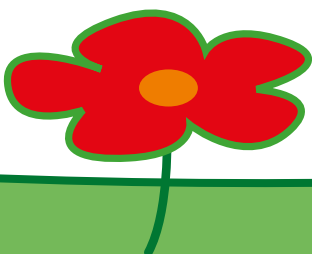

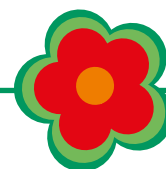

PERCORSI NIDO H.20 NURSERY PATHS H.20

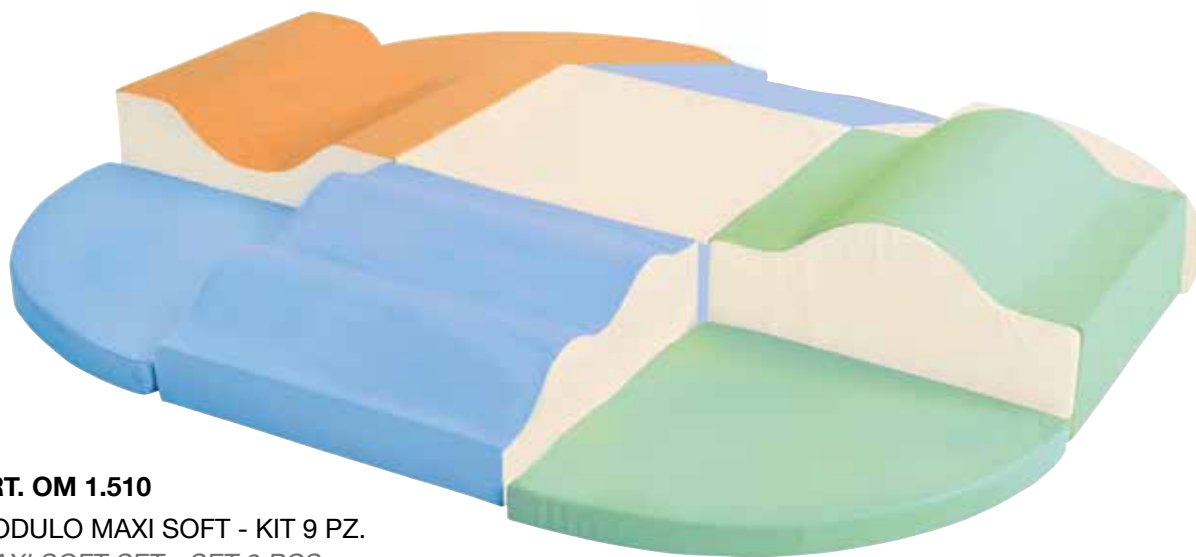

ART. OM 1.510

MODULO MAXI SOFT - KIT 9 PZ.
MAXI SOFT SET - SET 9 PCS.



Composizione di 9 elementi / *Composition of 9 elements:*
pedana soft 1 pz. / *soft pad 1 pc.*
onda convessa soft 1 pz. / *soft convex wave 1 pc.*
onda concava soft 1 pz. / *soft concave wave 1 pc.*
onda doppia soft 1 pz. / *soft double wave 1 pc.*
scivolino soft 1 pz. / *soft little slide 1 pc.*
tappeto 90° soft 4 pz. / *soft carpet 90° 4 pcs.*

SINGOLI COMPONENTI / SINGLE COMPONENTS

Art. OM 1.503

Pedana soft / *Soft pad*
Dim. cm. 60 x 60 x 20 h
colore: panna/azzurro
color: cream/blue

Art. OM 1.504

Onda convessa soft / *Soft convex wave*
Dim. cm. 65 x 60 x 20/10 h
colore: arancio/panna
color: orange/cream

Art. OM 1.505

Onda concava soft / *Soft Concave wave*
Dim. cm. 65 x 60 x 20/30 h
colore: verde/panna
color: green/cream

Art. OM 1.506

Onda doppia soft / *Soft double wave*
Dim. cm. 65 x 60 x 20/10 h
colore: azzurro/panna
color: blue/cream

Art. OM 1.507

Scivolino soft / *Soft little slide*
Dim. cm. 65 x 60 x 20/0 h
colore: azzurro/panna
color: blue/cream

Art. OM 1.508

Tappeto 90° soft / *Soft carpet 90°*
Dim. cm. 65 lato - kit 4 pezzi
Side cm. 65 - Set 4 pcs.

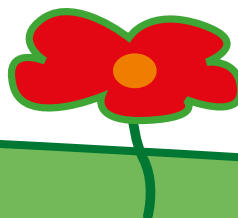



PERCORSI NIDO H.20 NURSERY PATHS H.20

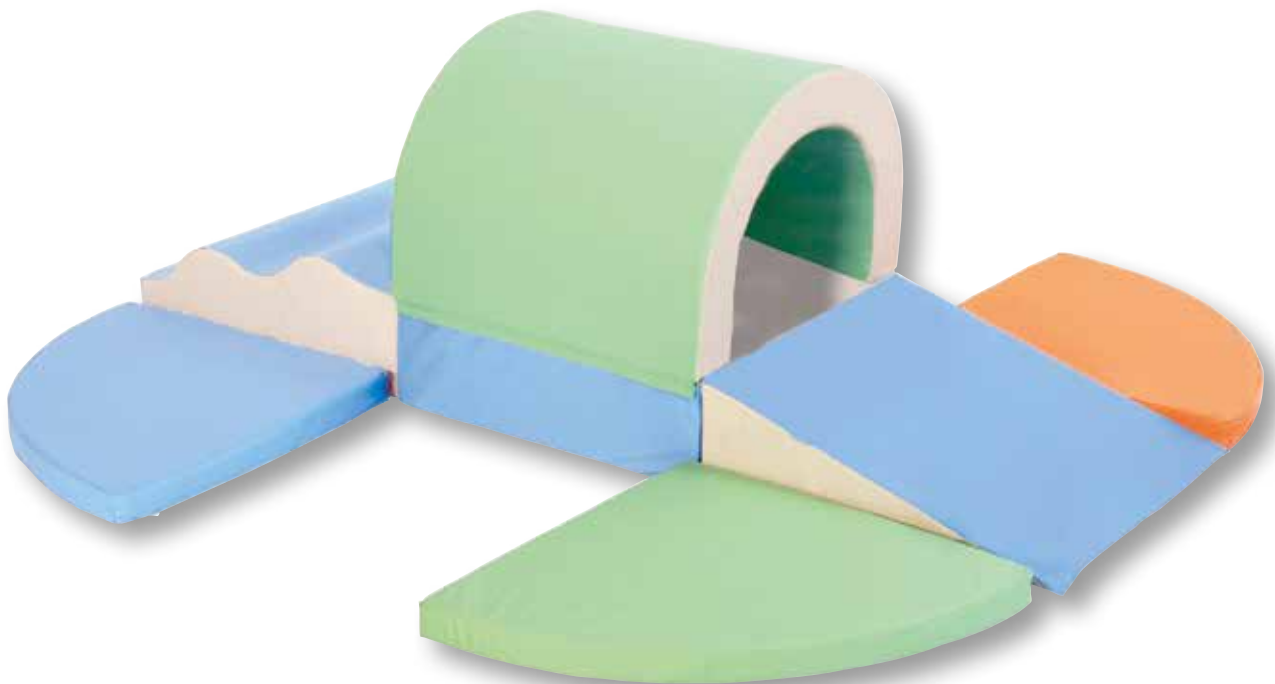

Art. OM 1.511

MODULO START SOFT - KIT 8 PZ.
START SOFT SET - SET 8 PCS.

Composizione di 8 elementi / Composition of 8 elements:

pedana soft 1 pz. / soft pad 1 pc.
onda doppia soft 1 pz. / soft double wave 1 pc.
scivolino soft 1 pz. / soft little slide 1 pc.
tunnel soft 1 pz. / soft tunnel 1 pc.
tappeto 90° soft - 4 pz. / soft carpet 90° - 4 pcs.



SINGOLI COMPONENTI / SINGLE COMPONENTS

Art. OM 1.503

Pedana soft / Soft pad
Dim. cm. 60 x 60 x 20 h
colore: panna/azzurro
color: cream/blue

Art. OM 1.506

Onda doppia soft / Soft double wave
Dim. cm. 65 x 60 x 20/10 h
colore: azzurro/panna
color: blue/cream

Art. OM 1.507

Scivolino soft / Soft little slide
Dim. cm. 65 x 60 x 20/0 h
colore: azzurro/panna
color: blue/cream

Art. OM 1.509

Tunnel soft / Soft Tunnel
Dim. cm. 60 x 60 x 45 h
colore: verde/panna
color: green/cream

Art. OM 1.508

Tappeto 90° soft / Soft carpet 90°
Dim. cm. 65 lato
kit 4 pezzi
Side cm. 65
Set 4 pcs.

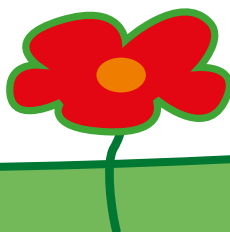
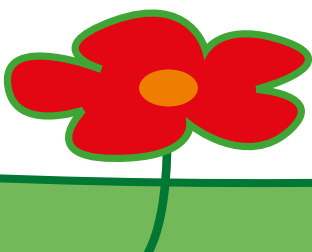

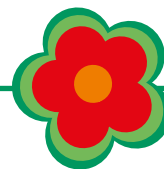

PERCORSI NIDO H.20 NURSERY PATHS H.20



Art. OM 1.512

MODULO MINI SOFT - KIT 3 PZ.
MINI SOFT SET - SET 3 PCS.

Composizione di 3 elementi / *Composition of 3 elements:*
pedana soft 1 pz. / *soft pad 1 pc.*
onda convessa soft 1 pz. / *soft convex wave 1 pc.*
onda concava soft 1 pz. / *soft concave wave 1 pc.*

SINGOLI COMPONENTI / SINGLE COMPONENTS

Art. OM 1.503

Pedana soft
Soft pad

Dim. cm. 60 x 60 x 20 h
colore: panna/azzurro
color: cream/blue

Art. OM 1.504

Onda convessa soft
Soft convex wave

Dim. cm. 65 x 60 x 20/10 h
colore: arancio/panna
color: orange/cream

Art. OM 1.505

Onda concava soft
Soft concave wave

Dim. cm. 65 x 60 x 20/30 h
colore: verde/panna
color: green/cream

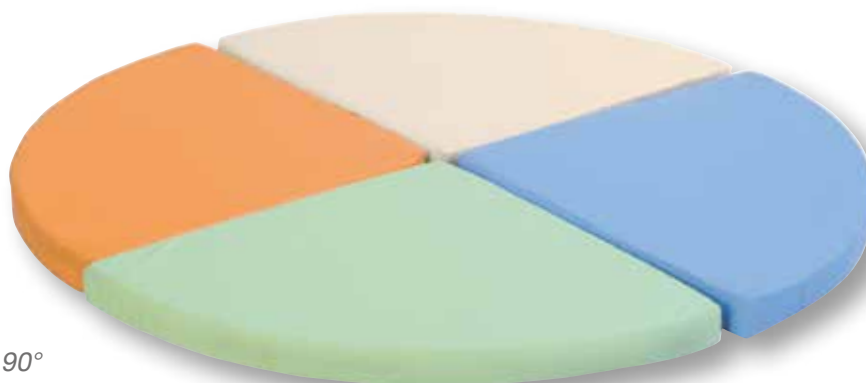

Art. OM 1.508

Tappeto 90° soft / *Soft carpet 90°*
Dim. cm. 65 lato - kit 4 pezzi
Side cm. 65 - Set 4 pcs.

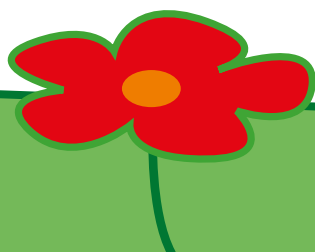

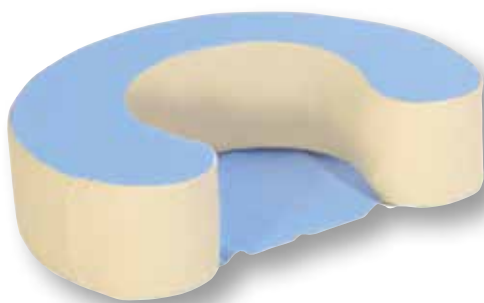

Art. OM 1.515

Anello soft 2 / *Soft ring 2*
Dim. cm. 60 x 45 x 15 h
colore: azzurro/panna
color: blue/cream



Art. OM 1.514

Anello soft 1 / *Soft ring 1*
Dim. cm. 60 x 45 x 15 h
colore: verde/arancio
color: green/orange

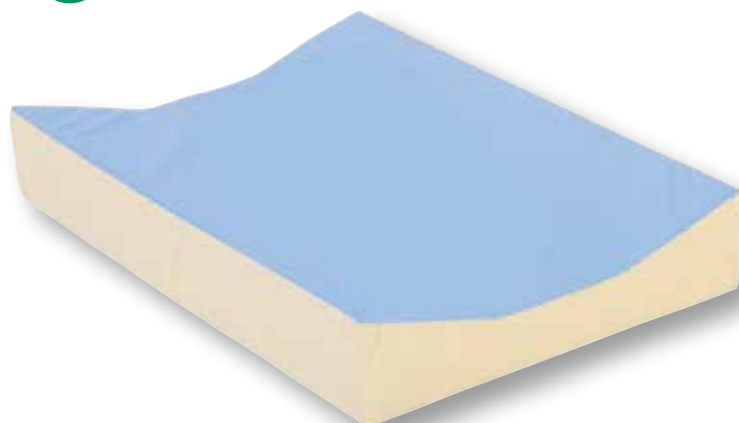

Art. OM 1.513

Fasciatoio soft / *Soft Changing mat*
Dim. cm. 100 x 60 x 10/5 h



Art. OM 1.517

Bruco nido soft
Nursery soft caterpillar
Interno in poliester
Polyester interior
Dim. cm. 180 x 20 (lu x Ø)



Art. OM 1.516

Arrampicata soft / *Soft climbing set*
Dim. cm. 165 x 80 x 40 h
Base corredata da 7 cilindri con Ø differenziati
Soft base complete with 7 cylinders having different diameters

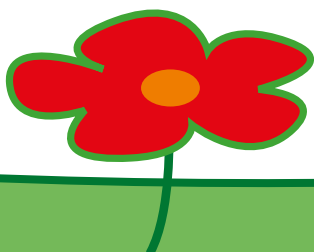

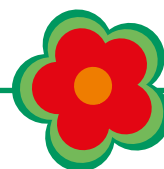

Art. OM 1.518/A

Tappeto rettangolare soft
Rectangular soft carpet
Dim. cm. 130 x 65 x 4 h
Bicolore: azzurro/panna
Two colors: blue/cream

Art. OM 1.518/B

Tappeto rettangolare soft
Rectangular soft carpet
Dim. cm. 130 x 65 x 4 h
Bicolore: verde/arancio
Two colors: green/orange



Art. OM 1.519/A

Tappeto quadrato soft
Square soft carpet
Dim. cm. 130 x 130 x 4 h
Bicolore: azzurro/panna
Two colors: blue/cream

Art. OM 1.519/B

Tappeto quadrato soft
Square soft carpet
Dim. cm. 130 x 130 x 4 h
Bicolore: verde/arancio
Two colors: green/orange



Art. OM 1.520

Tappeto maxi soft
Maxi soft carpet
Dim. cm. 260 x 260 x 4 h
con maniglie (cuscini esclusi)
with handles (cushions not included)





Art. OM 1.532

Pouf a spicchi soft
Coloured wedges soft pillow
Interno con poliestere
Polyester interior
Dim. cm. 130 x 30 (Ø x h)

Art. OM 1.535

Maxi pouf soft
Maxi soft pillow
Interno con poliestere
Polyester interior
Dim. cm. 140 x 140 x 30 h

Art. OM 1.533

Cuscinotti 42x42 soft
Soft cushions 42x42
Interno in poliestere - Kit 8 pezzi
Polyester interior - Set 8 pcs.



Art. OM 1.534

Cuscinoni 70x70 soft
Giant soft cushions 70x70
Interno in poliestere - Kit 4 pezzi
Polyester interior - Set 4 pcs.

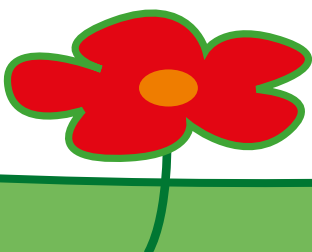

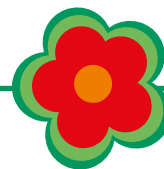

PERCORSI BABY H.30 BABY PATHS H.30



Art. OM 1.529

MODULO TOP SOFT - KIT 11 PZ.
TOP SOFT SET - SET 11 PCS.

Composizione di 11 elementi
Composition of 11 elements:

pentabase soft 1 pz. / pentagonal soft base 1 pc.
scaletta soft 1 pz. / soft step 1 pc.
onda soft 1 pz. / soft wave 1 pc.
scivolo soft 1 pz. / soft slide 1 pc.
pendio soft 1 pz. / soft slope 1 pc.
rullonda soft 1 pz. / soft rolls wave 1 pc.
tappeto 72° soft 5 pz. / soft carpet 72° 5 pc.

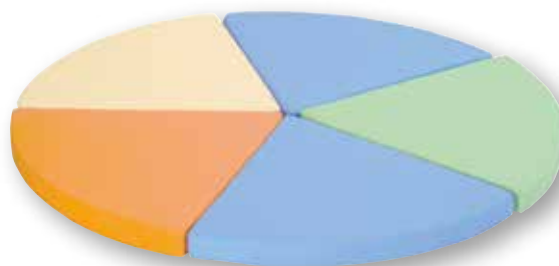

SINGOLI COMPONENTI / SINGLE COMPONENTS

Art. OM 1.528

Pentabase soft
Pentagonal soft base
Dim. cm. 95 x 100 x 30 h
colore: verde/panna
color: green/cream

Art. OM 1.523

Onda soft
Soft wave
Dim. cm. 90 x 60 x 30 h
colore: azzurro/panna
color: blue/cream

Art. OM 1.525

Pendio soft / Soft slope
Dim. cm. 70 x 60 x 30 h
colore: arancio/panna
color: orange/cream

Art. OM 1.522

Scaletta soft
Soft step
Dim. cm. 70 x 60 x 30 h
colore: arancio/panna
color: orange/cream

Art. OM 1.524

Scivolo soft
Soft slide
Dim. cm. 70 x 60 x 30 h
colore: verde/panna
color: green/cream

Art. OM 1.526

Rullonda soft / Soft rolls wave
Dim. cm. 70 x 60 x 30 h
Base corredata da 3 cilindri con Ø differenziati
Soft base complete with 3 cylinders
having different diameters

Art. OM 1.527

Tappeto 72° soft / Soft carpet 72°
Dim. cm. 65 lato - kit 5 pezzi
Side cm. 65 - Set 5 pcs.





PERCORSI BABY H.30 BABY PATHS H.30

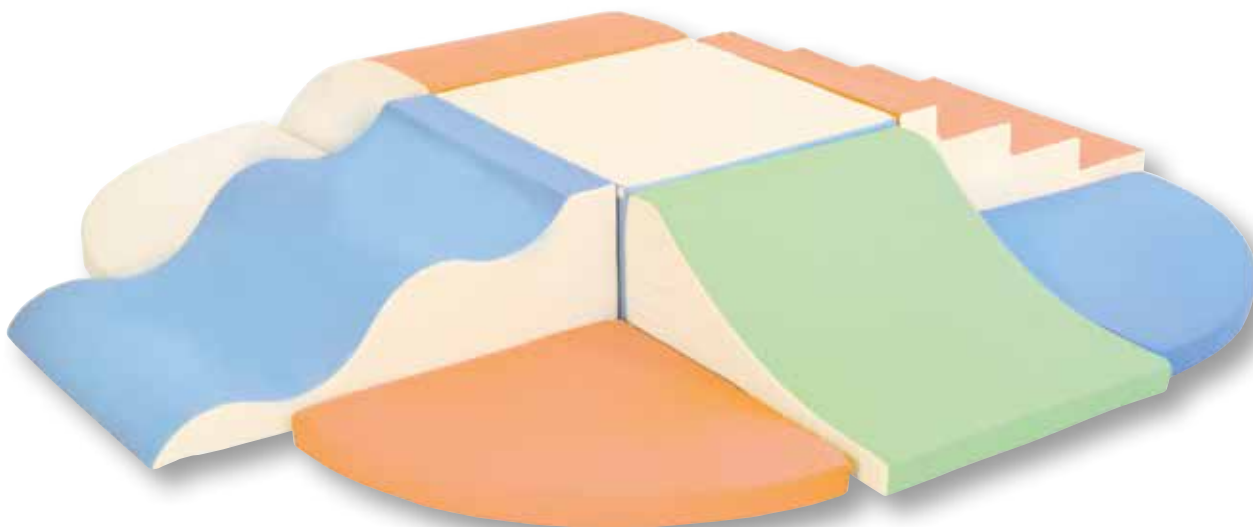

ART. OM 1.530

MODULO BASE SOFT - KIT 9 PZ.

BASE SOFT SET - SET 9 PCS.

Composizione di 9 elementi / Composition of 9 elements:

base soft 1 pz. / soft base 1 pc.

scaletta soft 1 pz. / soft step 1 pc.

onda soft 1 pz. / soft wave 1 pc.

scivolo soft 1 pz. / soft slide 1 pc.

pendio soft 1 pz. / soft slope 1 pc.

tappeto 90° soft - 4 pz. / soft carpet 90° - 4 pcs.



SINGOLI COMPONENTI / SINGLE COMPONENTS

Art. OM 1.521

Base soft / Soft base

Dim. cm. 60 x 60 x 30 h

colore: panna/azzurro

color: cream/blue

Art. OM 1.523

Onda soft / Soft wave

Dim. cm. 90 x 60 x 30 h

colore: azzurro/panna

color: blue/cream

Art. OM 1.525

Pendio soft / Soft slope

Dim. cm. 70 x 60 x 30 h

colore: arancio/panna

color: orange/cream

Art. OM 1.522

Scaletta soft / Soft step

Dim. cm. 70 x 60 x 30 h

colore: arancio/panna

color: orange/cream

Art. OM 1.524

Scivolo soft / Soft slide

Dim. cm. 70 x 60 x 30 h

colore: verde/panna

color: green/cream

Art. OM 1.508

Tappeto 90° soft

Soft carpet 90°

Dim. cm. 65 lato - kit 4 pezzi

Side cm. 65 - Set 4 pcs.

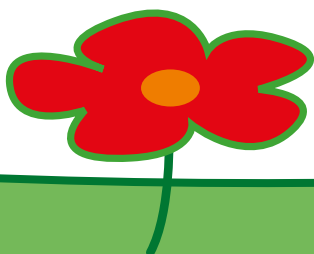

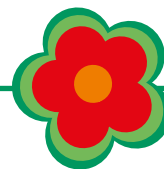

PERCORSI BABY H.30 BABY PATHS H.30

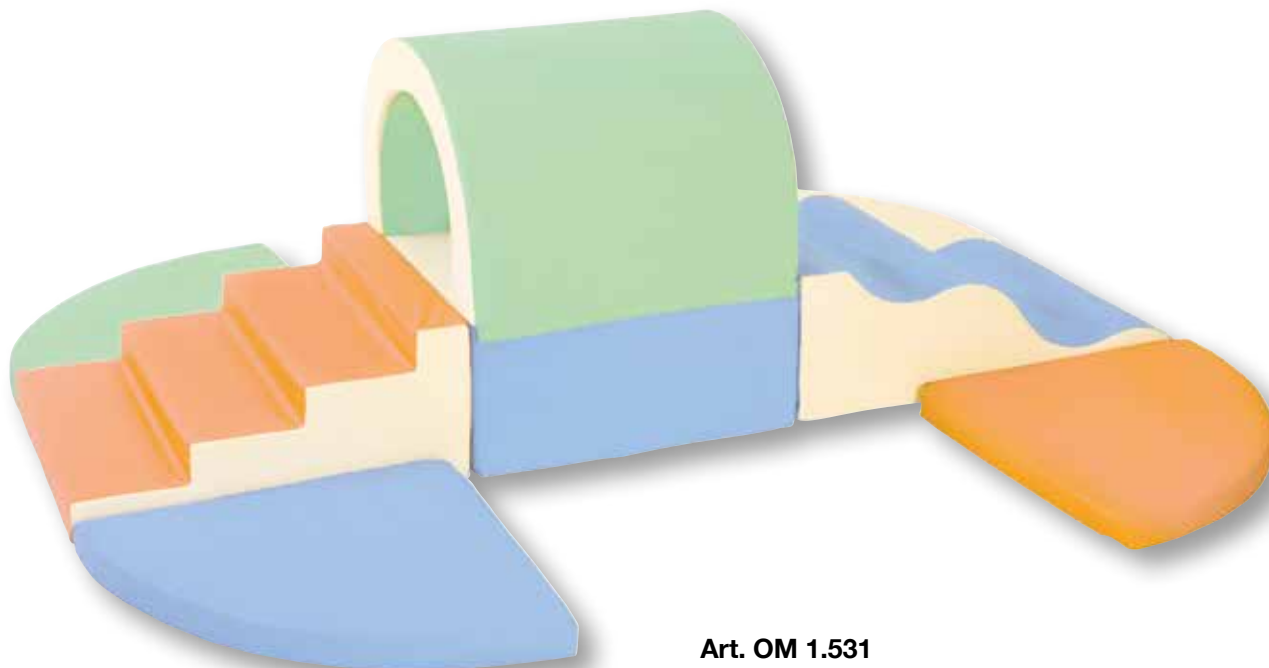

Art. OM 1.531

MODULO TUNNEL SOFT - KIT 8 PZ.
TUNNEL SOFT SET - SET 8 PCS.

Composizione di 8 elementi
Composition of 8 elements:

base soft 1 pz. / soft base 1 pc.
scaletta soft 1 pz. / soft step 1 pc.
onda soft 1 pz. / soft wave 1 pc.
tunnel soft 1 pz. / soft tunnel 1 pc.
tappeto 90° soft 4 pz. / soft carpet 90° 4 pcs.

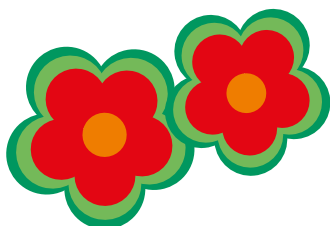

SINGOLI COMPONENTI / SINGLE COMPONENTS

Art. OM 1.521

Base soft / Soft base
Dim. cm. 60 x 60 x 30 h
colore: panna/azzurro
color: cream/blue

Art. OM 1.522

Scaletta soft / Soft step
Dim. cm. 70 x 60 x 30 h
colore: arancio/panna
color: orange/cream

Art. OM 1.523

Onda soft / Soft wave
Dim. cm. 90 x 60 x 30 h
colore: azzurro/panna
color: blue/cream

Art. OM 1.509

Tunnel soft / Soft Tunnel
Dim. cm. 60 x 60 x 45 h
colore: verde/panna
color: green/cream

Art. OM 1.508

Tappeto 90° soft / Soft carpet 90°
Dim. cm. 65 lato
Side cm 65
kit 4 pezzi / Set 4 pcs.

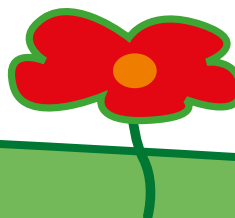



Art. OM 1.538

TANA NIDO SOFT - KIT 13 PZ.

NURSERY SOFT NEST SET - SET 13 PCS.

Composizione di 13 elementi / Composition of 13 elements:

box tana nido soft 1 pz. / nursery soft nest box 1 pc.

scaletta soft 1 pz. / soft step 1 pc.

onda soft 1 pz. / soft wave 1 pc.

scivolo soft 1 pz. / soft slide 1 pc.

pendio soft 1 pz. / soft slope 1 pc.

cuscini 42x42 soft 8 pz. / cushions 42x42 8 pcs.



Art. OM 1.539

Box tana nido soft

Nursery soft nest box

Dim. cm. 140 x 140 x 40 h

dotato di telo e materasso di fondo

comes with bottom sheet and mattress

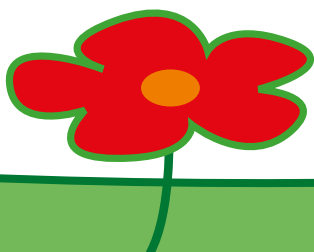

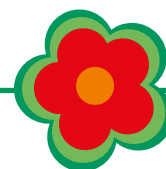

PISCINE / POOLS



Art. OM 1.536

MARE NIDO SOFT - KIT 9 PZ.

NURSERY SEA SOFT SET - SET 9 PCS.

Composizione di 9 elementi / *Composition of 9 elements:*

box mare nido soft 1 pz. / *nursery sea box 1 pc.*

scaletta soft 1 pz. / *soft step 1 pc.*

onda soft 1 pz. / *soft wave 1 pc.*

scivolo soft 1 pz. / *soft slide 1 pc.*

pendio soft 1 pz. / *soft slope 1 pc.*

cuscinoni 70x70 soft 4 pz. / *giant cushions 70x70 4 pcs.*



Art. OM 1.537

Box mare nido soft

Nursery sea soft box

Dim. cm. 180 x 180 x 30 h

dotato di telo e

materasso di fondo

comes with bottom

sheet and mattress





Art. OM 1.548

Set forme Baby - Base 20
Baby Shapes set - Base 20

Confezione da 7 forme
geometriche con rivestimento bicolore

7 geometric shapes pack
with double color finish

NUOVO ANGOLO SEDUTE LINEA NIDO / NEW CORNER NURSERY LINE SOFAS

Colori: le patelle laterali sono di colore panna e le sedute possono essere fornite nei 3 colori della Linea Nido (azzurro, arancio, verde acqua)

Colors: side flaps are color cream and sofas can be supplied in the 3 colors from the Nursery Collection (light blue, orange, water green)



Art. OM 1.550

Poltroncina Nido / *Little armchair*
Dim. cm 35 x 48 x 50 h
Altezza seduta cm 25 h - Bicolore
Seat height cm 25 h - Double color

Art. OM 1.551

Sofà Nido 2 posti - *2 seater Sofa*
Dim. cm 70 x 48 x 50 h
Altezza seduta cm 25 h - Bicolore
Seat height cm 25 h - Double color

Art. OM 1.552

Sofà Nido 3 posti - *3 seater Sofa*
Dim. cm 100 x 48 x 50 h
Altezza seduta cm 25 h - Bicolore
Seat height cm 25 h - Double color

Art. OM 1.553

Pouf Nido angolare - *corner pouf*
Dim. cm 48 x 48 x 25 h
Bicolore / *Double color*

Art. OM 1.554

Pouf Nido quadrato - *square pouf*
Dim. cm 48 x 48 x 25 h
Bicolore / *Double color*

Art. OM 1.555

Pouf Nido circolare - *round pouf*
Dim. cm 38 x 25 (Ø x h)
Bicolore / *Double color*

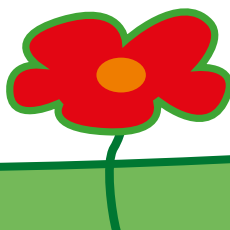

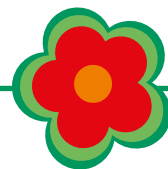

ANGOLO MORBIDO / SOFT CORNER



Art. OM 1.545

ANGOLO RELAX SOFT - KIT 13 PZ.

RELAX SOFT CORNER - SET 13 PCS.

Composizione di 13 elementi / Composition of 13 elements:

pedana relax 1 pz. / relaxing soft mattress 1 pc.

protezione murale soft 4 pz. / wall soft protection 4 pcs.

cuscinotti 42x42 soft 8 pz. / soft cushions 42x42 8 pcs.



Art. OM 1.546

Pedana relax soft / Relaxing soft mattress

Dim. pedana aperta cm. 200 x 200 x 15 h

Dim. pedana chiusa cm. 280 x 200 x 30 h

Open mattress dim. cm. 200 x 200 x 15 h

Folded mattress dim. cm. 280 x 200 x 30 h

Art. OM 1.547

Protezione murale soft h.130

Wall soft protection h.130

Dim. cm. 100 x 130 h

spessore cm. 4 / thickness 4 cm.

Ancoraggio a muro con velcro

Wall anchoring through Velcro

Colori disponibili / Available colors:

1.547/A - arancio / orange

1.547/B - verde / green

1.547/C - panna / cream

1.547/D - azzurro / blue

A richiesta può essere fornita
su misura della parete

Customized dimensions
available upon request

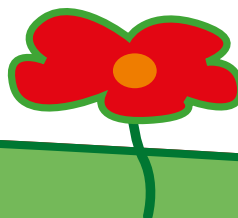
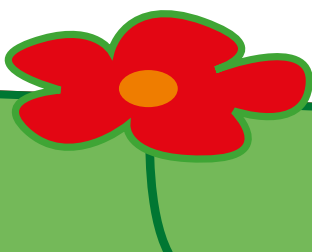

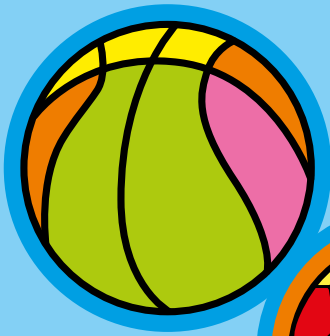

Linea SPORT SPORT Line



INFORMAZIONI TECNICHE / TECHNICAL INFORMATION

INTERNI: realizzati in poliuretano espanso tagliato in lastre completamente antipolvere.

Le diverse densità utilizzate (16 - 22 - 25) vengono indicate per ogni singolo articolo.

RIVESTIMENTI: in materiale plastico goffrato particolarmente robusto, bispalmato con le seguenti caratteristiche:

IGNIFUGO CL 2 - ATOSSICO

ANTIBATTERICO - ANTIMUFFA

FUNGICIDA - IMPERMEABILE - ANTIABRASIVO

LAVABILE CON DETERGENTI NORMALI

ACCESSORI: tutti i materassi sono dotati di fodere con chiusura a lampo e pertanto è possibile sfoderare e sostituire, nel tempo, ogni singolo rivestimento. Le cerniere utilizzate sono particolarmente robuste e dotate di cursori arrotondati. Tutti i materassi sono dotati di maniglie a doppia cucitura di colore blu.

I materassi di spessore cm. 30-40 sono corredati di fori di sfianto e maniglie rinforzate esternamente.

I tappetoni a libro sono ancorati tra loro mediante fasce di velcro da cm. 5. Tutti gli articoli sono disponibili in 2 versioni: senza antisdrucchiolo e con antisdrucchiolo. L'antisdrucchiolo applicato, di colore grigio e particolarmente resistente, consente al materasso una grande aderenza al suolo.

COLORI: i materassi e le protezioni sono disponibili unicamente nel colore blu.

ARTICOLI SU MISURA: tutti i materassi, possono essere forniti, a richiesta, con densità, spessori e dimensioni diverse. Il nostro ufficio tecnico è a vostra disposizione per eventuali preventivi.

INTERIORS: made of polyurethane foam cut into panels completely dustproof.

The different densities used (16 - 22 - 25) are indicated for each item.

COVERINGS: The plastic material is textured to make it particularly strong, coated on both sides with the following characteristics:

FIREPROOF CL 2 - ATOXIC

ANTIBACTERIAL - ANTI-MOULD

FUNGICIDE - WATERPROOF - ANTIABRASIVE

WASHABLE WITH NORMAL DETERGENTS

ACCESSORIES: all mats linings have zip closures, so that they can be easily replaced any time. Zippers used are particularly robust and equipped with rounded cursors. All mattresses have double-stitched handles in blue color. The mattresses cm thick. 30-40 are equipped with vent holes and externally reinforced handles.

The heavy rugs are anchored together by means of Velcro straps cm. 5. All items are available in 2 versions: without anti slipping and with anti slipping. Anti slipping used, grey in color and very durable, provides great grip to the ground.

COLOURS: mats and protections are only available in blue color.

TAILORED ITEMS: all mats, can be provided, upon request, with different densities, thicknesses and sizes. Please contact our technical department for any requirements.

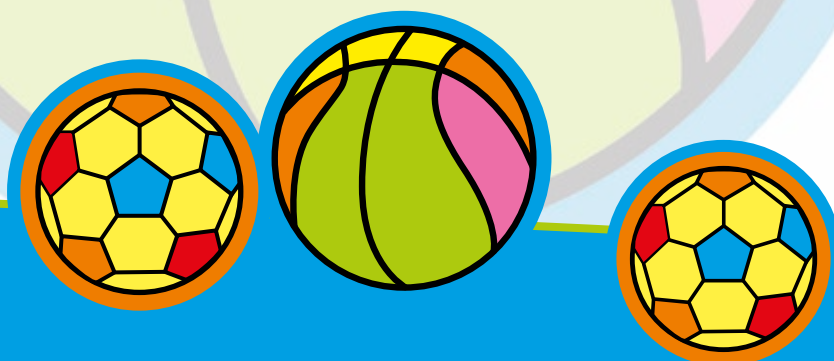



MATERASSI MATTRESS



MATERASSI GINNICI SPORT MATS

Dim. cm. 200x100x6	D. 22
Dim. cm. 200x100x10	D. 22
Dim. cm. 200x100x20	D. 16
Dim. cm. 200x100x30	D. 16
Dim. cm. 200x100x40	D. 16
Dim. cm. 200x200x6	D. 22
Dim. cm. 200x200x10	D. 22
Dim. cm. 300x200x6	D. 22
Dim. cm. 300x200x10	D. 22
Dim. cm. 300x200x20	D. 16
Dim. cm. 300x200x30	D. 16
Dim. cm. 300x200x40	D. 16

S/ANTISDRUCCIOLO WITHOUT ANTI SLIPPING

Art. OM 3.301/S
Art. OM 3.302/S
Art. OM 3.303/S
Art. OM 3.304/S
Art. OM 3.305/S
Art. OM 3.306/S
Art. OM 3.307/S
Art. OM 3.308/S
Art. OM 3.309/S
Art. OM 3.310/S
Art. OM 3.311/S
Art. OM 3.312/S

C/ANTISDRUCCIOLO WITH ANTI SLIPPING

Art. OM 3.311/SA
Art. OM 3.312/SA
Art. OM 3.313/SA
Art. OM 3.314/SA
Art. OM 3.315/SA
Art. OM 3.316/SA
Art. OM 3.317/SA
Art. OM 3.318/SA
Art. OM 3.319/SA
Art. OM 3.320/SA
Art. OM 3.321/SA
Art. OM 3.322/SA



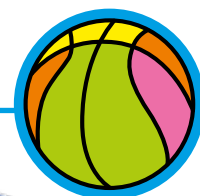

Art. OM 3.299/S

Materassino / *Small Mattress*
Dim. cm. 180 x 70 x 6 - Blu / Blue



Art. OM 3.300/S

Materassino Pieghevole
Folding Mattress
Dim. cm. 180 x 60 x 4 - Blu / Blue



**CUNEI
WEDGES**

Dim. cm. 100x100x30/0 - D.25
Dim. cm. 100x100x40/0 - D.25

**S/ANTISDRUCCIOLO
WITHOUT ANTI SLIPPING**

Art. OM 3.501/C
Art. OM 3.502/C

**C/ANTISDRUCCIOLO
WITH ANTI SLIPPING**

Art. OM 3.511/CA
Art. OM 3.512/CA



**MAT. A LIBRO PIEGHEVOLI
FOLDING MATS**

Dim. cm 200x200x20
(Chiuso/*folded* cm 200x100x40) D.16
Dim. cm 200x200x30
(Chiuso/*folded* cm 200x100x60) D.16
Dim. cm 200x200x40
(Chiuso/*folded* cm 200x100x80) D.16
Dim. cm 400x200x20
(Chiuso/*folded* cm 200x200x40) D.16
Dim. cm 400x200x30
(Chiuso/*folded* cm 200x200x60) D.16
Dim. cm 400x200x40
(Chiuso/*folded* cm 200x200x80) D.16

**S/ANTISDRUCCIOLO
WITHOUT ANTI SLIPPING**

Art. OM 3.401/S
Art. OM 3.402/S
Art. OM 3.403/S
Art. OM 3.404/S
Art. OM 3.405/S
Art. OM 3.406/S

**C/ANTISDRUCCIOLO
WITH ANTI SLIPPING**

Art. OM 3.411/SA
Art. OM 3.412/SA
Art. OM 3.413/SA
Art. OM 3.414/SA
Art. OM 3.415/SA
Art. OM 3.416/SA

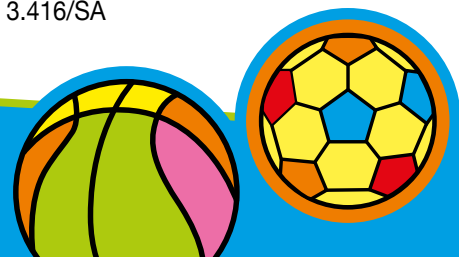

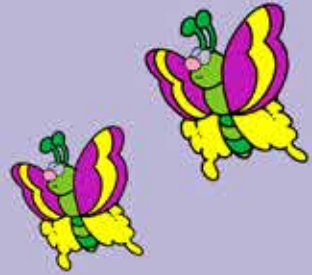



Cremona Giochi e Arrdi di Bonini Franco & C snc
Via Montanara, 22/23/26 - 26039 Vescovato (CR)
Tel. 0372 830320 - Fax 0372 831028
www.cremonagiochi.com - e-mail: cremona.snc@tin.it

